

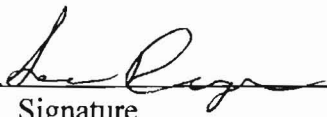
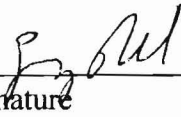
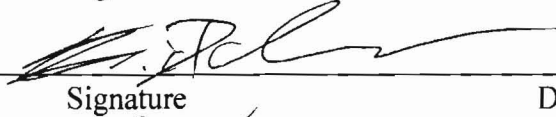

# INFORMATION ONLY

## Sandia National Laboratories Waste Isolation Pilot Plant

### Analysis Report for the Shielded Container Performance Assessment, Revision 1.0

Author:	Sean C. Dunagan (6711)		11/8/2007
Print		Signature	Date
Author:	Gregory T. Roselle (6712)		11/8/2007
Print		Signature	Date
Author:	Eric D. Vugrin (6711)		11/8/07
Print		Signature	Date
Author:	Jennifer J. Long (6711)	 for Jennifer Long	11/8/07
Print		Signature	Date
Technical			
Review:	Thomas B. Kirchner (6711)		11/8/07
Print		Signature	Date
QA			
Review:	Mario J. Chavez (6710)		11/8/07
Print		Signature	Date
Management			
Review:	Moo Y. Lee (6711)		11/8/07
Print		Signature	Date

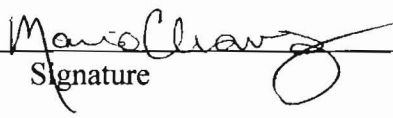
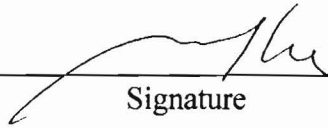
## EXECUTIVE SUMMARY

The Waste Isolation Pilot Plant (WIPP) is a deep geologic repository developed by the U.S. Department of Energy (DOE) for the disposal of transuranic (TRU) radioactive waste. Containment of TRU waste at the WIPP is regulated by the U.S. Environmental Protection Agency (EPA) according to the requirements set forth in Title 40 of the Code of Federal Regulations (CFR), Part 191. The DOE demonstrates compliance with the containment requirements according to the Certification Criteria in Title 40 CFR, Part 194 by means of performance assessment (PA) calculations that are conducted by Sandia National Laboratories (SNL). WIPP PA calculations are used to estimate the probability and consequence of radionuclide releases from the repository to the accessible environment for a regulatory period of 10,000 years after facility closure.

Previous PAs have used the assumption that all remote-handled (RH) waste would be emplaced in canisters in the walls of the repository. DOE is proposing the use of a shielded container to emplace a portion of the RH waste. This shielded container would be placed on the floor of the repository in a manner similar to that used for contact-handled (CH) waste disposal. Thus, DOE tasked SNL to assess the impact of emplacing RH waste in shielded containers on the long term performance of the repository by conducting performance analysis using the current baseline PA system, making only those changes necessary to represent shielded containers in the WIPP.

The Shielded Container Performance Assessment (SCPA) was conducted in a five step process under "Analysis Plan to Assess the Impact of Shielded Container Emplacement in the Waste Isolation Pilot Plant" (AP-135, Dunagan and Vugrin 2007):

1. Evaluate the WIPP PA baseline assumptions, models, and parameters to determine which are affected by the use of shielded containers;
2. Develop an analysis design to incorporate necessary modifications to the baseline approach;
3. Develop necessary parameters for the SCPA;
4. Execute WIPP PA codes; and
5. Conduct an analysis of results, including a comparison with baseline predictions of long term repository performance.

The review of baseline assumptions determined that the primary modification that needed to be made to the WIPP PA baseline assumptions was the re-location of the RH waste from the boreholes in the walls of the repository to the floor of the repository. This would also require the creation of new parameters to represent this change in certain PA models. The new parameters would represent the fraction of repository volume occupied by waste and the area for RH waste disposal in the walls of the repository for scenarios that model the inclusion of shielded containers. It was determined that no other changes to the baseline were necessary to represent the presence of shielded containers.

Due to uncertainty pertaining to the quantity of RH waste that could be emplaced in shielded containers, the SCPA used a bounding approach to model what waste would be packaged in

shielded containers. The baseline scenario assumes that all of the RH waste is located in the walls of the repository, emplaced in canisters. SCPA scenario 2 assumed that all of the RH waste would be emplaced in shielded containers, located on the floor of the repository. No other changes were made to the baseline approach for this scenario. SCPA scenario 3 assumed that half of the RH waste would be emplaced in shielded containers located on the floor of the repository and half of the RH waste would be emplaced in canisters located in the walls of the repository. No other changes were made to the baseline approach for this scenario. A comparison of the results from SCPA scenario 2 and SCPA scenario 3 to the baseline estimates of releases identified the effects the emplacement of shielded containers on repository performance.

In the baseline scenario (and SCPA scenarios 2 and 3), a single, composite waste stream was used to represent all of the RH waste. SCPA scenario 4 is a repeat of SCPA scenario 2, with the exception that the 77 individual RH waste streams are explicitly represented instead of using a single average waste stream to represent the RH waste. A comparison of the results from SCPA scenarios 2 and 4 identified the effects of using an average RH waste stream to represent all RH waste.

This analysis concludes that the WIPP continues to comply with the containment requirements specified in 40 CFR 191.13 when representing the disposal of RH waste in shielded containers. Analysis results with shielded containers are not discernibly different than the results of the current compliance baseline. Moreover, this analysis concludes that the packaging and emplacement of RH waste in shielded containers has no discernable impact on releases. This statement applies to all release pathways: cuttings and cavings, spallings, direct brine releases, groundwater releases, and total releases. Furthermore, the explicit representation of individual RH waste streams is not warranted since the representation of RH waste with a single, composite RH waste stream does not result in discernibly different results than when individual RH waste streams are used.

**TABLE OF CONTENTS**

**1 INTRODUCTION ..... 7**

**2 BACKGROUND..... 8**

2.1 CURRENT METHODS OF WASTE EMPLACEMENT ..... 8

2.2 SHIELDED CONTAINERS ..... 11

    2.2.1 *Waste Streams Eligible for Emplacement in Shielded Containers*..... 11

    2.2.2 *Emplacement of Shielded Containers*..... 12

2.3 RH WASTE CHARACTERISTICS AND IMPACT ON RELEASES..... 12

**3 SCPA METHODOLOGY..... 16**

3.1 EVALUATION OF SHIELDED CONTAINER IMPACT ON WIPP PA BASELINE IMPLEMENTATION ..... 17

    3.1.1 *Contents of Waste Materials* ..... 18

    3.1.2 *Emplacement and Container Materials*..... 18

    3.1.3 *Room Closure*..... 19

    3.1.4 *Chemical Conditions*..... 20

    3.1.5 *Heterogeneity of Waste Placement*..... 25

    3.1.6 *Repository Temperature*..... 25

    3.1.7 *Impact of Waste Location on Release Mechanisms*..... 27

    3.1.8 *Impact of Shielded Containers on Release Mechanisms*..... 28

    3.1.9 *Location of RH Waste Streams*..... 29

    3.1.10 *Summary of SCPA Implementation Issues*..... 30

3.2 DEVELOPMENT OF THE ANALYSIS DESIGN ..... 31

3.3 PARAMETERS DEVELOPMENT ..... 31

3.4 EXECUTION OF WIPP PA CODES ..... 32

3.5 ANALYSIS OF RESULTS..... 32

3.6 DEVIATIONS FROM AP-135 ..... 32

**4 RESULTS..... 33**

4.1 COMPARISON OF SCENARIOS 2 AND 3 TO THE CRA-2004 PABC ..... 33

4.2 COMPARISON OF SCENARIO 2 TO SCENARIO 4..... 37

**5 SUMMARY AND CONCLUSIONS ..... 38**

**6 REFERENCES ..... 40**

**APPENDIX A: ADDITIONAL FIGURES..... 45**

**APPENDIX B: RUN CONTROL ..... 49**

**List of Figures**

Figure 1. CH Waste Packaging Configurations in the WIPP. The black drums in the picture are 55-gallon drums shrink wrapped together into a 7-pack, and the containers on the floor are TDOPs. A SWB is placed on top of a TDOP on the right side of the picture. At the top of each stack is a supersack of MgO. .... 9

Figure 2. RH-TRU Waste Canister (from page A-3 of DOE 1995). The pintle component of the canister is shown in the lower portion of the figure and is used during the loading of canisters..... 10

Figure 3. Isometric Exposed View of the Shielded Container..... 11

Figure 4. Total Activity vs. Time for RH and CH Waste. .... 15

Figure 5. Average Activity Density vs. Time for RH and CH Waste..... 15

Figure 6. Mean Normalized Total Releases and RH Releases from CRA-2004 PABC Replicate 1. .... 16

Figure 7. Partial Cross-Section of the (a) Shielded Container and (b) RH-TRU Container (Not to Scale)..... 27

Figure 8. Mean Total Releases from SCPA Scenarios 2 and 3 and CRA-2004 PABC, Replicate 1. .... 35

Figure 9. Mean Cuttings and Cavings Releases from SCPA Scenarios 2 and 3 and CRA-2004 PABC, Replicate 1. .... 35

Figure 10. Mean Spallings Releases from SCPA Scenarios 2 and 3 and CRA-2004 PABC, Replicate 1. .... 36

Figure 11. Mean DBRs from SCPA Scenarios 2 and 3 and CRA-2004 PABC, Replicate 1. .... 36

Figure 12. Mean Total Releases from SCPA Scenario 2 and Scenario 4, Replicate 1. .... 37

**List of Tables**

Table 1. CH Waste Material Densities (from Table ES-1 DOE 2006b)..... 13  
Table 2. RH Waste Material Densities (from Table ES-2 DOE 2006b)..... 13  
Table 3. CH Waste Emplacement Materials (Crawford and Taggart 2007)..... 13  
Table 4. CH and RH Waste Radionuclide Inventories (Table ES-5 from DOE 2006b) <sup>1, 2</sup>..... 14  
Table 5. CRA-2004 PABC Replicate 1 Releases at Probabilities of 0.1 and 0.001. .... 16  
Table 6. Components of WIPP PA That Could Potentially be Affected by Shielded Containers. 17  
Table 7. Cellulose, Plastic, and Rubber (CPR) RH Packaging and Emplacement Materials When  
All RH Waste is Packaged in Shielded Containers. .... 18  
Table 8. SCPA Approach to Modeling Issues Listed in Table 6. .... 30  
Table 9 Parameters Created for the SCPA..... 32  
Table 10. RH Areas for the CRA-2004 PABC and SCPA Scenarios 2 and 3. .... 37

## 1 INTRODUCTION

The Waste Isolation Pilot Plant (WIPP) is a deep geologic repository developed by the U.S. Department of Energy (DOE) for the disposal of transuranic (TRU) radioactive waste. Containment of TRU waste at the WIPP is regulated by the U.S. Environmental Protection Agency (EPA) according to the requirements set forth in Title 40 of the Code of Federal Regulations (CFR), Part 191. The DOE demonstrates compliance with the containment requirements according to the Certification Criteria in Title 40 CFR, Part 194 by means of performance assessment (PA) calculations that are conducted by Sandia National Laboratories (SNL). WIPP PA calculations are used to estimate the probability and consequence of radionuclide releases from the repository to the accessible environment for a regulatory period of 10,000 years after facility closure.

PA calculations were included in DOE's 1996 WIPP Compliance Certification Application (CCA, DOE 1996), and in a subsequent Performance Assessment Verification Test (PAVT, MacKinnon and Freeze 1997a, 1997b, 1997c). Based in part on the CCA and PAVT PA calculations, the EPA certified that the WIPP met the containment criteria, and the WIPP was approved for disposal of transuranic waste in May 1998 (EPA 1998). PA calculations were also an integral part of DOE's 2004 WIPP Compliance Recertification Application (CRA-2004, DOE 2004). During their review of the CRA-2004, the EPA requested an additional performance assessment calculation be conducted with modified assumptions and parameter values (Cotsworth 2005). This PA is referred to as the WIPP 2004 Compliance Recertification Application Performance Assessment Baseline Calculation (CRA-2004 PABC, Leigh et al. 2005a), and when the EPA recertified the WIPP in March 2006 (EPA 2006), the CRA-2004 PABC was established as the WIPP PA technical baseline.

On January 24, 2007, the WIPP received the first shipment of remote-handled (RH) TRU waste (DOE 2007). RH waste is currently packaged for disposal in RH-TRU waste canisters. These canisters are loaded into boreholes that are drilled in the walls of the WIPP waste disposal rooms. To improve operational efficiency, DOE is now proposing a change to the emplacement of RH waste. DOE proposes to package a subset of RH waste streams in containers with lead-shielding, and these shielded containers would be placed on the floor of the disposal rooms, similar to the emplacement of contact-handled (CH) waste containers.

DOE has tasked SNL to assess the impact of emplacing RH waste in shielded containers on the long term performance of the repository by conducting a performance analysis. SNL conducted an impact assessment, termed the Shielded Container Performance Assessment (SCPA), and analyzed the results. The PA was conducted in accordance with "Analysis Plan to Assess the Impact of Shielded Container Emplacement in the Waste Isolation Pilot Plant" (AP-135), which was written specifically to guide the execution of this PA. This document details how SNL conducted the SCPA and analyzed its results.

Following this introduction (Section 1), Section 2 provides background details on current waste emplacement methods, the characteristics of RH waste, and the impact of RH waste on WIPP PA

releases. Section 3 details the methodology and approach used for designing and conducting the SCPA. A key step was an evaluation of how the use of shielded containers could potentially impact WIPP PA baseline assumptions, parameters, and models. This section also contains an extensive discussion of that evaluation and modifications that were made to the baseline as a result of that evaluation in order to conduct the SCPA. Section 4 presents the results of the SCPA calculation and analysis of those results. Finally, Section 5 summarizes how the use of shielded containers impacts long term repository performance.

## **2 BACKGROUND**

### ***2.1 Current Methods of Waste Emplacement***

WIPP operations currently use different disposal methods for CH and RH waste. CH waste is emplaced in a number of different container configurations. Examples of the different waste container configurations include 7-packs of 55-gallon drums, 10-drum overpacks (TDOPs), and standard waste boxes (SWBs). The CH waste container configurations are generally placed in stacks of three on the disposal room floors, with TDOPs being the exception. TDOPs are approximately the height of two stacks of 55-gallon drums, and they are always placed directly on the room floor with a single additional waste container configuration on top. The CH waste is emplaced in the rooms as it arrives. Figure 1 displays an example of CH waste as it is emplaced at the WIPP, and the various container configurations can be seen, as well.



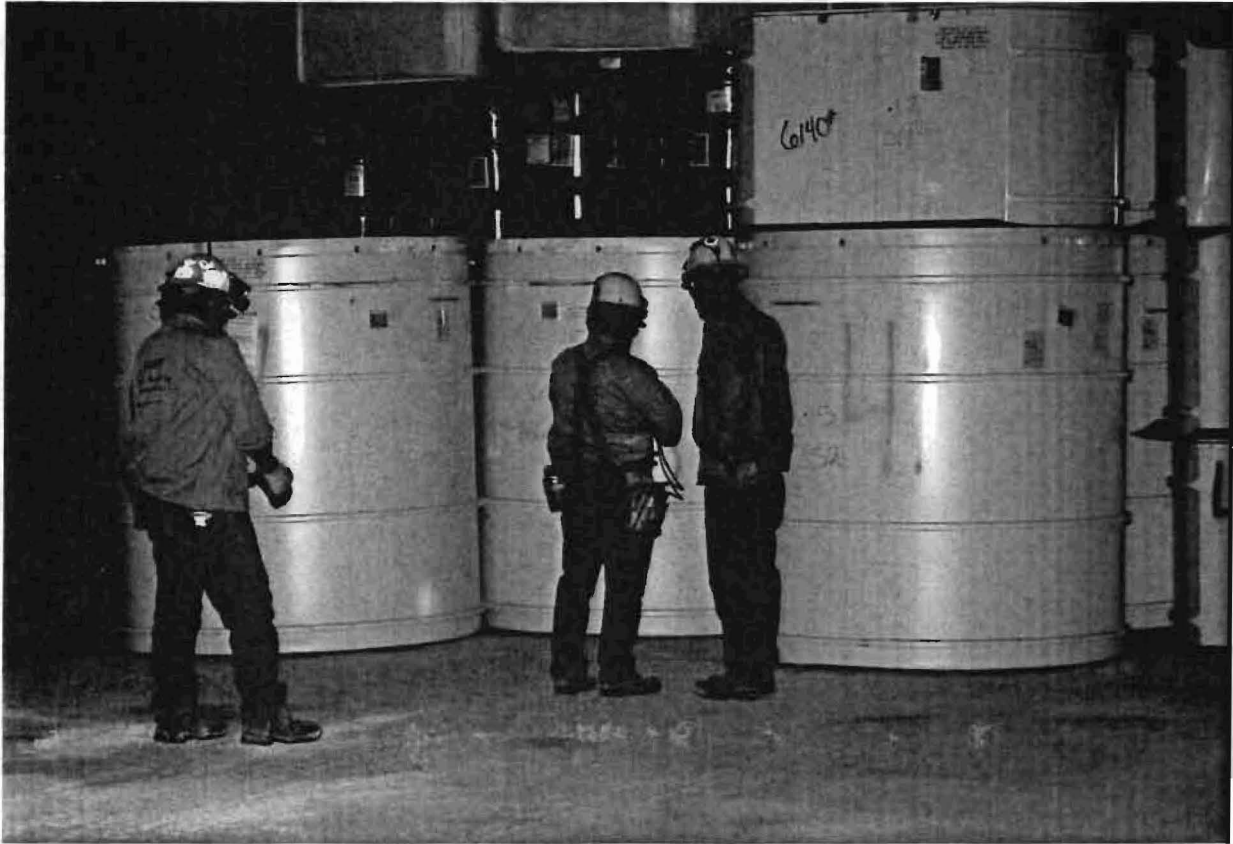

**Figure 1. CH Waste Packaging Configurations in the WIPP. The black drums in the picture are 55-gallon drums shrink wrapped together into a 7-pack, and the containers on the floor are TDOPs. A SWB is placed on top of a TDOP on the right side of the picture. At the top of each stack is a supersack of MgO.**

Currently, RH waste is disposed in the RH-TRU waste canister (Figure 2). This canister is cylindrical in shape; its length is 120.5 in, and it has a diameter of 26 in. The canisters have a nominal wall thickness of 0.25 in, and they are made entirely of steel. The canister is either directly loaded with RH waste, or it is packaged with RH waste containers (e.g., 55-gallon drums or metal cans) (DOE 2006a). The canisters are placed in horizontal holes that are drilled perpendicular to the faces of the walls of the repository rooms.

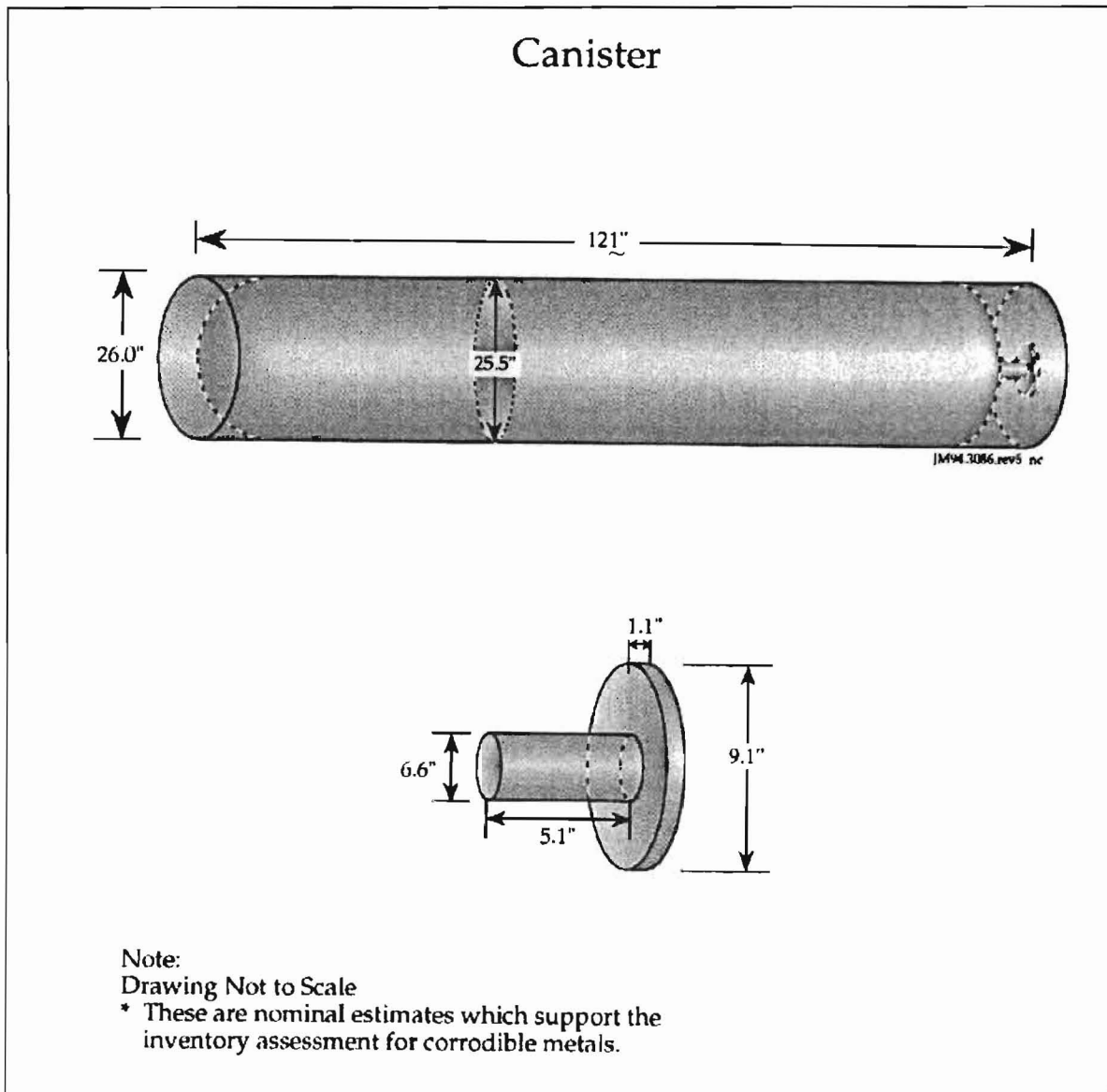
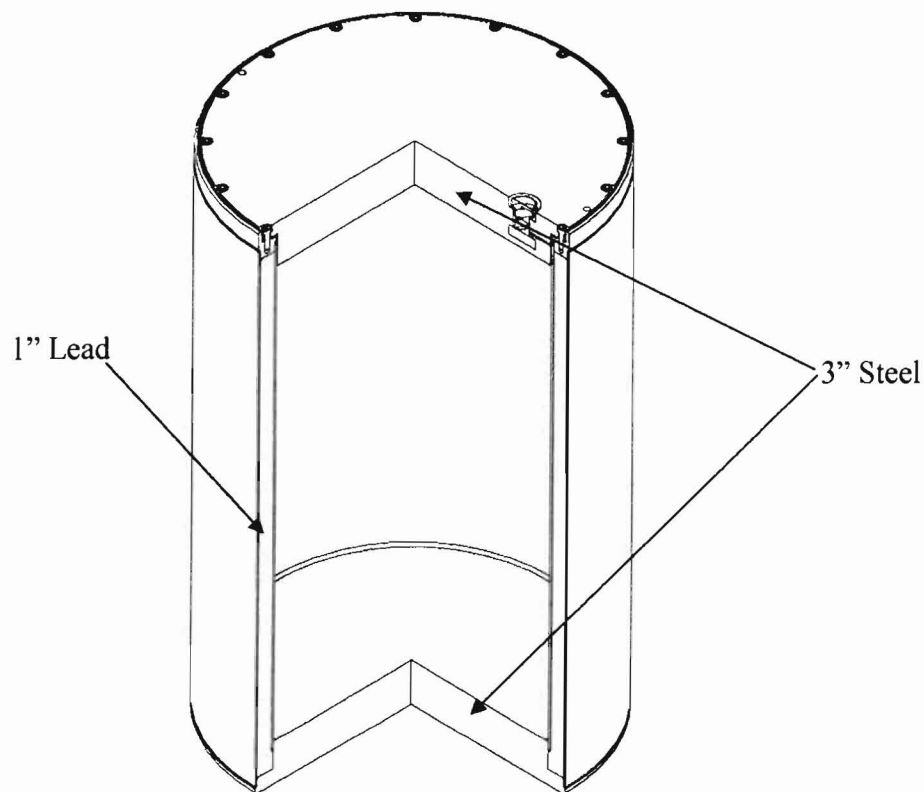

**Figure 2. RH-TRU Waste Canister (from page A-3 of DOE 1995). The pintle component of the canister is shown in the lower portion of the figure and is used during the loading of canisters.**

The efficiency of the current RH waste emplacement process could be improved to emplace RH waste faster. The current process requires the use of specialized equipment to drill holes perpendicular to the faces of the repository walls. Only activities solely dedicated to the RH borehole drilling may be conducted while emplacing RH canisters into the boreholes. The disruption of the CH emplacement puts a significant strain on overall repository operations. The use of shielded containers would improve the efficiency of RH waste emplacement.

**2.2 Shielded Containers**

DOE is proposing to emplace a portion of the RH waste in shielded containers on the floor of the waste emplacement rooms with the CH waste containers. The shielded container is designed to hold a standard 30-gallon drum, and has approximately the same exterior dimensions as a standard 55-gallon drum. The cylindrical sidewall of the shielded container has 1-inch-thick lead shielding sandwiched between a double-walled steel shell. The external wall is 1/8 inch thick, and the internal wall has a thickness of 3/16 inch. The lid and bottom of the container are made from steel and are 3.0 inch thick. Figure 3 gives a schematic of the shielded container design, and additional technical drawings of this design are included in Sellmer (2007).



**Figure 3. Isometric Exposed View of the Shielded Container.**

**2.2.1 Waste Streams Eligible for Emplacement in Shielded Containers**

In the current WIPP PA baseline inventory there are 690 CH waste streams and 77 RH waste streams (Leigh et al. 2005b). WIPP PA represents the RH inventory as one composite RH waste stream, and the activity of this composite waste stream is determined by taking a volume-weighted average of all 77 RH waste streams.

The shielded containers will be used for the emplacement of RH waste when the shielding in the containers is sufficient to lower the surface dose of the RH waste contents to within the

prescribed limits for CH waste. Crawford and Taggart (2007) indicate that waste containing less than 2 curies of Cs-137 or 0.12 curies of Co-60 per 30 gallon drum would be eligible for packaging in shielded containers. Using this criteria, Crawford and Taggart (2007) estimated that 1,922 m<sup>3</sup>, or approximately 27%, of the total RH waste inventory in the current baseline would be eligible for emplacement in shielded containers.

Crawford and Taggart (2007) note that there is some uncertainty in the amount of RH waste that could be placed in the shielded containers. Crawford and Taggart (2007) determined the volume of RH waste that would be packaged in shielded containers by determining which waste streams, on average, contained less than 2 curies of Cs-137 or 0.12 curies of Co-60 per 30 gallon drum. However, when the actual waste is packaged, the screening process will actually be performed on a container-by-container basis, not a waste stream basis. To handle this uncertainty, the SCPA has taken a bounding approach to modeling the quantity of waste packaged in shielded containers. (Note: This uncertainty applies to this assessment only, and not to waste characterization and acceptance processes.)

### 2.2.2 *Emplacement of Shielded Containers*

The shielded containers will be bundled in groups of 3 (3-packs) and emplaced on the floors of the waste rooms as it arrives. RH waste that is not packaged in shielded containers will be emplaced in the boreholes as previously described in Section 2.1.

### 2.3 *RH Waste Characteristics and Impact on Releases*

TRU waste is classified as either contact-handled (CH) or remote-handled (RH) based on the contact dose rate at the surface of the waste container. If the contact dose rate is less than 200 millirem per hour (2 milliSievert per hour), the waste is defined as CH-TRU (DOE 1988). If, on the other hand, the contact dose rate is greater than or equal to 200 millirem per hour, the waste and its container are defined as RH-TRU (DOE 1988). Consistent with the Land Withdrawal Act (US Congress 1992), only RH-TRU waste with a surface dose less than or equal to 1000 rem per hour (10 Sievert per hour) is eligible for disposal at the WIPP.

The remote-handled (RH) waste inventory is limited to a maximum volume of 7080 m<sup>3</sup> (250000 ft<sup>3</sup>) which accounts for approximately 4% of the total waste volume (DOE 2004). Moreover, the emplaced RH-TRU waste is not to exceed a total activity of 5.1 million Ci (~ 18.9 x 10<sup>16</sup> Becquerel) and a total activity concentration of 23 Ci per liter maximum activity level (averaged over the volume of the canister). No more than five percent of the emplaced RH-TRU waste may exhibit a dose rate in excess of 100 rem per hour (1 Sievert per hour).

Two waste characteristics that are of significance to performance assessment calculations are the steel (iron) content and cellulose, plastic, and rubber (CPR) material content. Table 1 and Table 2 (DOE 2006b) show that RH waste in the current inventory baseline has lower average densities of CPR materials than CH waste. Table 3 displays the CPR materials used for CH emplacement in the current inventory baseline. In the current inventory baseline no CPR materials are used for RH emplacement. RH waste in the current inventory baseline has a higher average density of

steel (iron) in container materials than CH waste and a lower average density for steel (iron) in waste material parameters than CH waste.

**Table 1. CH Waste Material Densities (from Table ES-1 DOE 2006b).**

Waste Material Parameters	Average Density (kg/m <sup>3</sup> )
Iron-Base Metal/Alloys	1.1E+02
Aluminum-Base Metal/Alloys	1.4E+01
Other Metal/Alloys	3.2E+01
Other Inorganic Materials	4.0E+01
Cellulosics	6.0E+01
Rubber	1.3E+01
Plastics	4.3E+01
<b>Container Materials</b>	
Steel	1.7E+02
Plastic	1.7E+01
Lead	1.3E-02

**Table 2. RH Waste Material Densities (from Table ES-2 DOE 2006b).**

Waste Material Parameters	Average Density (kg/m <sup>3</sup> )
Iron-Base Metal/Alloys	5.9E+01
Aluminum-Base Metal/Alloys	5.0E+00
Other Metal/Alloys	5.7E+01
Other Inorganic Materials	1.6E+01
Cellulosics	9.3E+00
Rubber	6.7E+00
Plastics	8.0E+00
<b>Container Materials</b>	
Steel	5.4E+02
Plastic	3.1E+00
Lead	4.2E+02

**Table 3. CH Waste Emplacement Materials (Crawford and Taggart 2007).**

	Emplacement Mass (kg)	Emplacement Density (kg/m <sup>3</sup> )
Cellulose	2.07E+05	1.22
Plastic	1.48E+06	8.78

There are several radionuclides, such as Cs-137, that have quite different average activity densities in RH waste as opposed to CH waste. Table 4 displays the average activity densities found in RH and CH waste for the radionuclides with the highest concentrations. As seen in this table, such radionuclides as Cs-137, Co-60, Sr-90 and Y-90 are much more prevalent in RH waste, but their impact on long-term performance is negligible because these radionuclide have relatively short half-lives of 30, 5, and 29 years and 2.67 days, respectively (Leigh and Trone 2005).

**Table 4. CH and RH Waste Radionuclide Inventories (Table ES-5 from DOE 2006b) <sup>1, 2</sup>.**

<b>Nuclide</b>	<b>CH Waste (Ci/m<sup>3</sup>)</b>	<b>RH Waste (Ci/m<sup>3</sup>)</b>
Am-241	2.8E+00	2.0E+00
Ba-137m	4.1E-02	5.6E+01
Cm-244	3.7E-02	1.5E-01
Co-60	5.8E-06	2.6E-01
Cs-137	4.4E-02	6.0E+01
Eu-152	1.1E-05	3.3E-01
Pu-238	8.6E+00	5.4E-01
Pu-239	3.4E+00	7.4E-01
Pu-240	5.6E-01	2.2E-01
Pu-241	1.2E+01	1.8E+01
Sr-90	3.3E-01	4.6E+01
Y-90	3.3E-01	4.5E+01

1-Summary shows the ten radionuclides with the highest concentration in curies per cubic meter for both CH-TRU and RH-TRU waste. The list includes twelve radionuclides because the ten radionuclides with the highest concentration are different for CH-TRU and RH-TRU waste.

2-Decayed through December 31, 2001.

The surface dose rate is determined by several factors, including container type and shielding, radiation type, and curie content. It should further be noted that an elevated surface dose rate, relative to that from CH waste, does not necessarily imply that RH waste has a higher total curie content or density. This note is important from a repository performance standpoint because curie content is a factor in determining releases, not surface dose.

The activity associated with RH waste is compared to that of CH waste in Figure 4 and Figure 5. As shown in these figures, RH waste activity is relatively small in total curies to CH waste, and RH has a lower density of EPA Units than CH waste has. The short half-lives of Cs-137, Co-60, and Sr-90 in RH waste result in a short interval over which RH waste has substantial activity. RH waste is expected to have little impact on long-term performance because the total RH waste activity is approximately 2 orders of magnitude of the total activity of CH waste (see Figure 4). This expectation is confirmed by the results with full PA methodology, as discussed next.

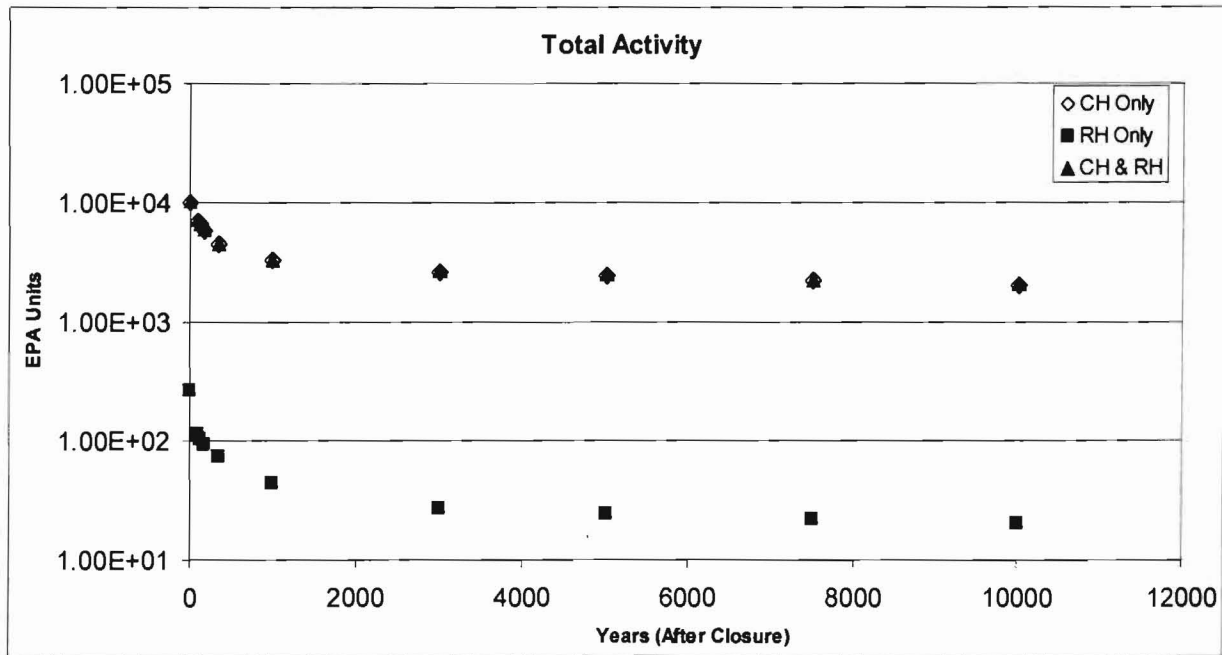

Figure 4. Total Activity vs. Time for RH and CH Waste.

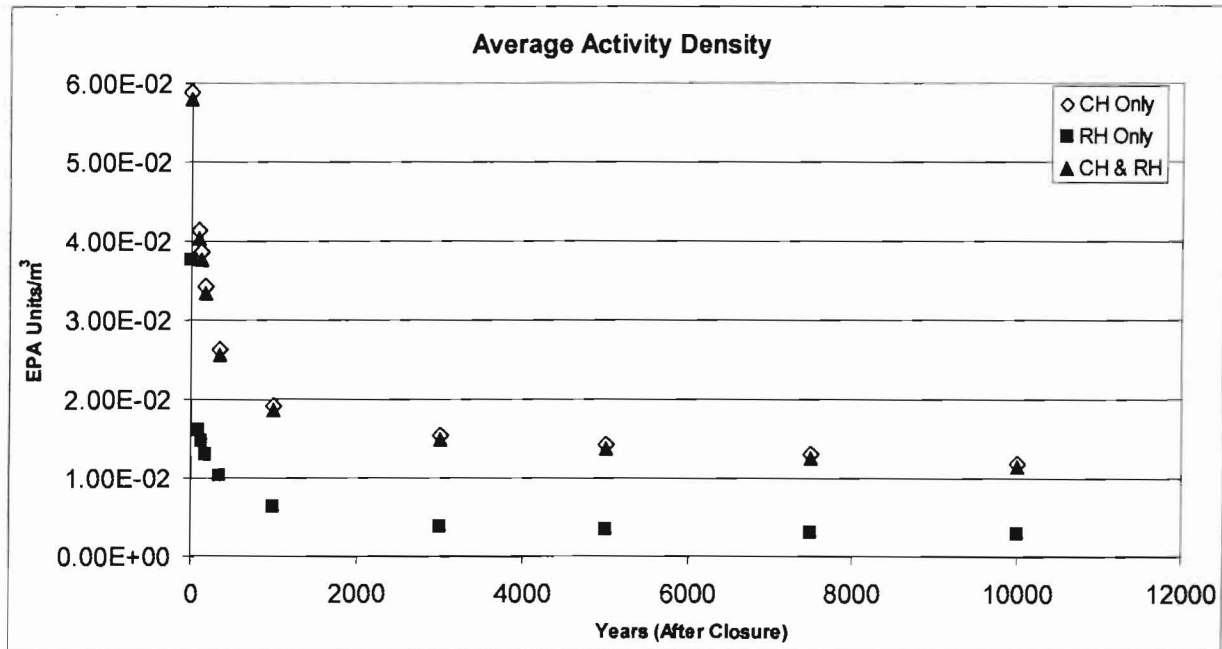

Figure 5. Average Activity Density vs. Time for RH and CH Waste.

The contribution of RH waste to total releases from the CRA-2004 PABC (Replicate 1) is shown in Figure 6. Two complementary cumulative distribution functions (CCDFs) are shown: the mean CCDF for total releases and the mean CCDF for releases of RH waste. As shown in this figure and Table 5, the releases attributed only to RH waste are generally two to three orders of magnitude lower than the total releases from both RH and CH wastes. Consequently, one can

conclude that releases of RH waste are not a significant contributor to total releases at any probability level.

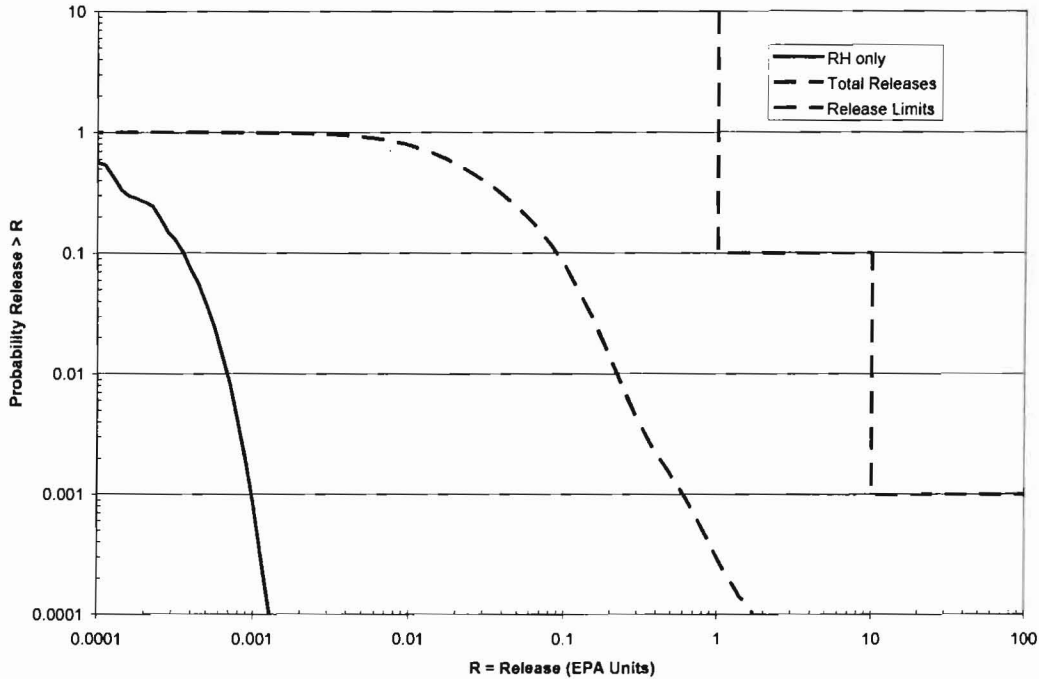

Figure 6. Mean Normalized Total Releases and RH Releases from CRA-2004 PABC Replicate 1.

Table 5. CRA-2004 PABC Replicate 1 Releases at Probabilities of 0.1 and 0.001.

	Probability = 0.1	Probability = 0.001
Total Releases (EPA units)	8.86E-02	5.98E-01
RH Releases (EPA units)	3.55E-04	9.82E-04

### 3 SCPA METHODOLOGY

The “Analysis Plan to Assess the Impact of Shielded Container Emplacement in the Waste Isolation Pilot Plant” (AP-135, Dunagan and Vugrin 2007) was developed specifically to guide the execution of the SCPA. The SCPA was conducted in a five step process:

1. Evaluate WIPP PA baseline assumptions, models, and parameters to determine which are affected by the use of shielded containers;
2. Develop an analysis design to incorporate necessary modifications to the baseline approach;
3. Develop necessary parameters for SCPA;
4. Execute WIPP PA codes; and
5. Conduct an analysis of results, including a comparison with baseline predictions of long term repository performance.



The following subsections detail the individual steps that were conducted to complete the SCPA.

**3.1 Evaluation of Shielded Container Impact on WIPP PA Baseline Implementation**

The DOE’s shielded container design and emplacement plans have been reviewed to assess how the use of these containers could potentially affect WIPP PA technical baseline assumptions and implementations. Table 6 shows components of WIPP PA that could be affected by emplacing the RH waste using shielded containers. The following subsections discuss how each PA component and possible implementation issues for each component were addressed in the SCPA.

**Table 6. Components of WIPP PA That Could Potentially be Affected by Shielded Containers.**

<b>Component</b>	<b>Possible Implementation Issue</b>
Contents of waste materials	Will the use of shielded containers affect the contents of waste materials and waste material mechanical properties?
Emplacement and container materials	Will the use of shielded containers affect the amount of steel and CPR materials associated with emplacement and container materials?
Room closure	Will the use of shielded containers affect room closure and the porosity of the waste areas?
Chemical conditions	Will the presence of lead in the shielded containers affect chemical conditions and actinide solubilities?
Waste emplacement	Will loading schemes and disposal schedules associated with the shielded containers present inconsistencies with the assumption of random waste emplacement?
Repository temperature	Will the use of shielded containers affect the repository temperature and heat distribution?
Impact of waste location on release mechanisms	Will emplacing RH waste on the floor of disposal rooms make it more/less accessible to release mechanisms?
Impact of shielded container properties on release mechanisms	Will the physical characteristics of the shielded containers affect release mechanisms?
Location of RH waste streams	Will the location of RH waste streams, on the floor versus in the walls, affect normalized release from the repository?

3.1.1 Contents of Waste Materials

The introduction of the shielded containers does not affect projected inventories for waste materials. Thus, parameters related to the waste inventory and mechanical properties of the waste are unaffected by the use of shielded containers. Consequently, the SCPA used the CRA-2004 PABC values for waste inventory parameters and the mechanical properties of the waste.

3.1.2 Emplacement and Container Materials

The impact of using shielded containers on emplacement and container materials has been evaluated by Crawford and Taggart (2007). At the time that SNL started to develop an analysis plan for the SCPA, there was some uncertainty as to what quantity of RH waste would be packaged in shielded containers, so SNL requested that Crawford and Taggart conduct their calculations under the assumption that all of the RH waste would be packaged in the shielded containers (Dunagan 2007a). This approach allowed Crawford and Taggart to identify an upper bound on the change in emplacement and container materials.

The baseline inventory contains 1.2E+09 moles of organic carbon from CPR materials (Nemer 2007). The RH waste contains 7.8E+06 moles of organic carbon, and the RH packaging materials contribute 1.4E+06 additional moles of organic carbon to the total inventory. There are no CPR emplacement materials associated with the current RH emplacement methodology.

When shielded containers are used to emplace RH waste, additional CPR emplacement materials will be needed since there will be more waste stacks on the floor of the repository. These emplacement materials include additional slip sheets, shrink wrap, and the supersacks that contain magnesium oxide (MgO). Table 7 contains Crawford's and Taggart's (2007) estimates for CPR materials. Crawford and Taggart (2007) found that no rubber will be used for packaging or emplacement of shielded containers.

**Table 7. Cellulose, Plastic, and Rubber (CPR) RH Packaging and Emplacement Materials When All RH Waste is Packaged in Shielded Containers.**

CPR Component	Mass from Packaging Materials (kg) <sup>1</sup>	Moles of Organic Carbon from Packaging Materials <sup>2,3</sup>	Mass from Emplacement Materials (kg) <sup>1</sup>	Moles of Organic Carbon from Emplacement Materials <sup>2,3</sup>
Cellulose	0.0E+00	0.0E+00	2.4E+04	8.9E+05
Plastic	1.1E+05	6.9E+06	4.3E+05	2.7E+07
Rubber	0.0E+00	0.0E+00	0.0E+00	0.0E+00

<sup>1</sup> Crawford and Taggart (2007)

<sup>2</sup> Moles of organic carbon in cellulose = mass in kg x (6000 moles/162 kg)

<sup>3</sup> Moles of organic carbon in plastic = mass in kg x (6000 moles/162 kg) x 1.7

As discussed previously in Section 3.1.1, the CPR contents of the waste materials will not change with the use of shielded containers, so the use of shielded containers only affects the CPR materials related to emplacement and packaging materials. Packaging all RH waste in shielded containers would increase the organic carbon quantity in the inventory by 3.3E+07 moles. This

quantity is calculated by summing the organic carbon from the packaging and emplacement materials for RH waste when shielded containers are used and subtracting the organic carbon for those materials from the baseline inventory ( $6.9E+06 + 8.9E+05 + 2.7E+07 - 1.4E+06 = 3.3E+07$ ). This difference from the baseline inventory represents less than a three percent increase ( $(3.3E+07+1.2E+09)/1.2E+09 = 0.0275$ ). (Again, it should be noted that the increase in organic carbon described above represents an upper bound since DOE will not actually put all the RH waste in shielded containers.)

This small increase is not large enough to significantly impact repository performance. Dunagan et al. (2005) performed an analysis in which they compared total radionuclide releases from two PAs that differed only in CPR inventories; one PA had 2.5 times the CPR content of the other PA. Total releases were not significantly affected by the increased CPR inventory, and repository pressures, repository brine saturations, and brine flow out of the waste areas were only minimally affected. Thus, an increase to the total CPR mass of only a few percent, far less than the increase studied by Dunagan et al. (2005), will not significantly impact PA results.

The quantity of steel and lead associated with RH waste emplacement and packaging materials will also be affected by the use of shielded containers. Section 3.1.4 includes a discussion of the impact on the inventory and how the changes to the inventory will not affect WIPP PA baseline models or calculations. Therefore, the SCPA used the CRA-2004 PABC steel and CPR inventories since changes to these quantities that are expected by the use of shielded containers will not significantly affect repository performance.

### 3.1.3 Room Closure

The presence of shielded containers in the disposal rooms could potentially affect room closure since the exterior dimensions of the shielded containers are similar to those of the 55-gallon drums but the walls of the shielded containers are thicker. Thus, the shielded container represents a stiffer waste package than the standard 55-gallon drum.

During the development of the performance assessment for the CCA, the DOE chose to represent waste with a constitutive model based on deformation of standard 55-gallon drums and developed conceptual and numerical models accordingly. An independent conceptual model panel reviewed these models and their results, and determined that DOE had adequately modeled waste in the disposal system (Wilson et al. 1996a, 1996b, 1997a, 1997b).

However, since that time, as the TRU waste sites have begun processing and shipping waste for emplacement in the WIPP, a number of other container types have been used (see Section 2.1). Given that varying waste types and waste packages were coming to or were intended to come to WIPP, the EPA expressed concern about the continued validity of performance assessment models based on the 55-gallon drum constitutive model and requested an investigation of the effects of varying waste types and associated packaging (Marcinowski 2003).

To respond to EPA's concerns, DOE conducted a PA that considered alternative waste types and associated packaging (Hansen et al. 2004). The PA also evaluated the significance of

assumptions about waste representation. In this PA, the structural and mechanical impact of the various waste packages on room closure was modeled by calculating and sampling several different porosity surfaces (Park and Hansen 2003). Porosity surfaces were calculated for a set of extreme bounding cases, one in which a panel contains only the compliant 55 gallon drums with a homogeneous mix of waste (referred to as the Standard Waste Model that was used in the CCA and PAVT) and another in which a panel contains only the stiff waste packages containing supercompacted waste. In the latter cases, the waste packages were assumed to be incompressible. Additional intermediate cases were considered as well. Based on that performance assessment, DOE concluded that:

- Explicit representation of the specific features of the waste and its associated packaging, such as structural rigidity, is not warranted in modeling since performance assessment results are relatively insensitive to the effects of such features.
- Total releases are essentially unchanged by the use of different porosity surfaces because when gas generation is present uncertainty in the constitutive model of the waste is overshadowed by the support provided by the generated gas pressure.

Furthermore, Hansen et al. (2004) showed that the Standard Waste Model used for the CCA resulted in the greatest variability in porosity and leads to the highest values for pressure in the repository. Thus, Hansen et al. (2004) concluded that performance assessment should use the Standard Waste Model for waste porosity. This model was used for waste porosity in the CRA-2004 PABC. EPA agreed with this conclusion, that stiff waste is beneficial (Marcinowski 2004).

Even though the shielded containers are more structurally rigid than the 55-gallon drums, the SCPA used the CRA-2004 PABC porosity surfaces that were calculated with the Standard Waste Model since repository performance is relatively insensitive to the structural rigidity of waste and waste containers as shown in Hansen et al. (2004).

#### *3.1.4 Chemical Conditions*

The emplacement of shielded containers in the WIPP has the potential to dramatically increase the amount of lead in the repository. The amount of iron present in the repository will also increase, although not as significantly as lead. The additional lead and iron have the potential to impact several aspects of the repository chemical environment such as: the redox conditions after repository closure, microbial gas generation due to consumption of CPR materials, consumption of microbially produced carbon dioxide (CO<sub>2</sub>) and the formation of actinide/organic ligand complexes. The impact of the additional lead and iron on each of these aspects has been reviewed and is discussed below. This review has determined that there is no significant impact on the chemical environment in the WIPP. As a result, the baseline approach used in the CRA-2004 PABC for modeling actinide solubility and other chemical environment parameters is appropriate to use in the SCPA.

### 3.1.4.1 Changes in Fe and Pb Densities due to Shielded Containers

The baseline estimates of iron densities at the repository closure are 110 and 59 kg/m<sup>3</sup>, in the CH and RH waste, and 170 and 540 kg/m<sup>3</sup>, in the CH and RH waste containers, respectively (Crawford 2005a). Given the total CH volume of 1.69E+05 m<sup>3</sup> and an RH volume of 7080 m<sup>3</sup> (U.S. Congress 1992), the estimated total mass of iron in the CH and RH wastes, including containers, is 4.7E+07 kg (8.4E+08 mol Fe) and 4.2E+06 kg (7.5E+07 mol Fe), respectively, which results in a total of 9.2E+08 mol Fe in WIPP. Estimates of the lead densities at closure are 1.3 E-02 and 4.2E+02 kg/m<sup>3</sup> for the CH and RH waste containers, respectively (Crawford 2005a). In addition to the lead in the waste containers, estimates have been made for the total quantity of lead and cadmium metal present within the waste materials for both CH and RH wastes at closure (Crawford 2005b). The estimated density of metal in the “lead/cadmium” waste stream is 1.5E+02 kg/m<sup>3</sup> for CH waste and 74 kg/m<sup>3</sup> for RH waste (Crawford 2005b). No differentiation was made between lead and cadmium in these estimates. Therefore, it is assumed that the total quantity of metal in the “lead/cadmium” waste stream is lead. Although this assumption provides an upper limit to the amount of lead in the “lead/cadmium” waste stream, there may be sources of lead in other waste streams, which have not been quantified. As a result, these estimates represent a lower limit of the amount of lead within the CH and RH wastes. Combining the above estimates results in an estimated total lead content within the WIPP at closure of 3.0E+06 kg, which is equal to 1.5E+07 mol. This represents an iron to lead molar ratio of 60 to 1 for the baseline estimates of total iron and lead in the repository.

An analysis by Crawford and Taggart (2007) estimates the amount of iron and lead in shielded containers that will be present in the repository at closure, assuming that all of the RH waste will be emplaced into shielded containers. Thus, the following analysis represents an upper bound on the amount of additional iron and lead introduced to the repository from shielded containers. The only metal densities that are impacted by shielded containers are estimates of iron and lead in the RH waste containers. There is no change to the estimated iron and lead densities for the CH containers or the contents of the waste streams. Crawford and Taggart (2007, Table 8) estimate an RH packaging density of 3.62E+03 kg/m<sup>3</sup> for steel and 3.81E+03 kg/m<sup>3</sup> for lead. By assuming that all of the steel can be considered as iron the emplacement of shielded containers results in total iron mass in the RH waste (including containers) of 2.6E+07 kg (4.7E+08 mol Fe), which is a six-fold increase over the baseline estimate of 4.2E+06 kg (7.5E+07 mol Fe) without shielded containers. However, this additional iron only increases the total mass of iron in the whole repository by approximately 40 percent ( $[(8.4E+08 + 4.7E+08)]/[8.4E+08 + 7.5E+07] = 1.4$ ) because most of the iron in the repository is contained in CH containers, which are not affected by the shielded container estimates.

The estimated packaging density for lead in the shielded containers results in a total lead mass of 2.7E+07 kg (1.3E+08 mol Pb) for the RH waste (including containers). This represents a nine-fold increase in the mass of lead in the RH waste. As a result the total mass of lead in the repository as a whole increases from 3.0E+06 kg (1.5E+07 mol Pb) to 2.7E+07 kg (1.3E+08 mol Pb). Because most of the lead in the repository is accounted for in the RH containers, the nine-fold increase in lead mass for the RH containers results in a similar nine-fold increase in the total

lead mass in the repository as a whole. This results in an iron to lead molar ratio of 10 to 1, which is a dramatic reduction from the baseline molar ratio of 60 to 1.

#### 3.1.4.2 Redox Conditions

The corrosion of steels and other metals in the WIPP will have a number of effects on the chemical environment in the repository that will have a direct effect on the dissolution and suspension of actinides. Of primary importance is that the oxic corrosion of steels will lead to reducing conditions in the repository, and these conditions are favorable with respect to the speciation of actinides (Appendix SOTERM, DOE 2004). After the available O<sub>2</sub> is consumed in the closed repository, the steels will undergo anoxic corrosion by the following reaction:



This reaction will consume water and lower brine saturation levels in the repository as well, which further benefits repository performance. Although it is known that the corrosion of iron in the repository will lead to anoxic conditions, no quantitative predictions of redox conditions (i.e. Eh) were made for the CRA-2004 PABC. Quantification of the redox state is difficult in low temperature geochemical systems because equilibrium among the many redox couples is generally not obtained. The effects of lead on the repository redox state were also not explicitly considered in the CRA-2004 PABC because of the relatively small amount of lead as compared to iron in the repository.

The possible effects of lead on the redox conditions of the repository were investigated by Wall and Enos (2006). Their initial set of thermodynamic calculations indicates that lead will oxidize in water at 25 °C and 1 atm. This oxidation process results in the formation of a number of lead species, with PbO(s) and Pb<sub>3</sub>O<sub>4</sub>(s) being the most likely to form in an anoxic environment like the WIPP. Wall and Enos (2006) also show that in the presence of CO<sub>2</sub> and H<sub>2</sub>S lead will form additional solid species such as PbCO<sub>3</sub> and PbS. Because lead corrodes in processes very similar to iron, the presence of lead provides additional evidence for the maintenance of redox conditions in the repository. In addition, the corrosion of lead also consumes water and will lower brine saturation levels in the repository.

Thus, the addition of lead into the repository due to shielded container emplacement is not expected to have a significant impact upon the redox conditions in the repository. No laboratory experiments have been conducted yet to study the lead corrosion process under WIPP conditions, and the rates of corrosion are not known. Due to the uncertainties relating to the corrosion of lead, the SCPA will not model lead corrosion. For the aforementioned reasons, this approach is conservative. A test plan (Wall and Enos 2006) has been written to conduct iron and lead corrosion studies under WIPP-like conditions, and Sandia is in the process of conducting these experiments.

#### 3.1.4.3 Microbial Gas Generation

The waste disposed within the WIPP contains significant quantities of CPR materials. In the CRA-2004 PABC microbial activity is assumed to consume some portion of the CPR materials over time resulting in the generation of significant quantities of CO<sub>2</sub>, H<sub>2</sub>S, hydrogen (H<sub>2</sub>), and nitrogen (N<sub>2</sub>). This microbial activity has the potential to significantly affect the mobility of actinides in several ways. The production of significant amounts of CO<sub>2</sub> due to microbial consumption of CPR materials is likely to have the greatest impact on the chemical environment in the WIPP. The presence of CO<sub>2</sub> will acidify any brine present in the repository and increase the solubilities of the actinides (Appendix SOTERM, DOE 2004). For this reason the DOE emplaces MgO into the repository to buffer the  $f_{\text{CO}_2}$  and pH within ranges that favor for lower actinide solubilities (Appendix BARRIERS, Section BARRIERS-2.0, DOE 2004). There are large uncertainties as to whether significant microbial activity will occur during the 10,000 year regulatory period at the WIPP. In the CRA-2004 PABC it was assumed that significant microbial gas generation occurs in all of the PA vectors. However, uncertainties were assigned for the type of gas generation occurring. It was also determined that the excess MgO would mitigate the effects of CO<sub>2</sub> production (Appendix SOTERM, DOE 2004).

WIPP PA implements microbial gas generation in what is considered to be a conservative manner. In WIPP PA models it is assumed that microbial gas generation will occur as long as water and CPR materials are present, despite the many uncertainties related to the microbial gas generation process. The addition of significant quantities of lead from the shielded containers has the potential to impact microbial gas generation in the repository. Heavy metals, such as lead, are known toxins for microorganisms. Numerous studies have shown that the short term response to heavy metal contamination is a large decrease in the overall microbial activity of the community, loss of diversity and a reduction in the total numbers of cells (Barnhart and Vestal 1983; Capone et al. 1983; Said and Lewis 1991). This would lead to a reduction in the amount of microbially generated gases, which could benefit repository performance. However, it has also been shown that environments with long term heavy metal contamination still contain significant microbial populations (Nieto et al. 1989; Konopka et al. 1999; Roane 1999; Zucconi et al. 2003). Thus, though it is quite likely that the presence of lead could negatively affect microbe viability and consequently decrease the amount of microbially generated gases, we cannot entirely rule out the possibility of microbial gas generation at this time. Therefore, the SCPA will utilize the conservative baseline implementation for microbial gas generation, and there will be no modification made to that model for any potential initial reduction in gas generation due to the presence of heavy metals.

#### 3.1.4.4 Carbon Dioxide Consumption

In addition to the MgO buffer, iron and lead could sequester carbon dioxide in the repository via carbonation, thus reducing the amount of carbon dioxide that must be consumed by MgO. Wall and Enos (2006) conducted a series of thermodynamic and mass balance calculations to investigate the extent to which iron and lead carbonation could affect the overall CO<sub>2</sub> budget of the repository. These calculations were based on the estimates of total carbon in the CPR and metal (iron and lead) densities used in the CRA-2004 PABC. Iron and lead will react with microbially produced CO<sub>2</sub> to form FeCO<sub>3</sub> and PbCO<sub>3</sub> via the reactions:

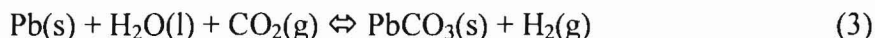
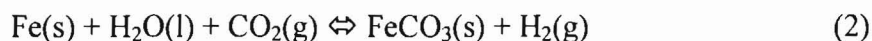

However, the analysis of Wall and Enos (2006) shows that  $\text{FeCO}_3$  and  $\text{PbCO}_3$  are unstable in the presence of sulfide. Thus the carbonates will react with  $\text{H}_2\text{S}$  that is produced via the sulfate reduction of CPR by microbial activity. This results in the production of  $\text{FeS}$  and  $\text{PbS}$  via the reactions;



A result of these reactions is that some of the  $\text{CO}_2$  consumed via reactions (2) and (3) will be released back into the repository chemical environment. Although the mass balance calculations of Wall and Enos (2006) show that iron and lead have the potential for significant  $\text{CO}_2$  sequestration, Brush and Roselle (2006) state that determining how much carbon dioxide would actually be consumed is difficult because of the uncertainties associated with that process (such as kinetic effects). In addition, WIPP PA models do not consider consumption of carbon dioxide by any material other than  $\text{MgO}$ . Thus, the SCPA will use the baseline approach for modeling carbon dioxide consumption and not model iron and lead carbonation.

#### 3.1.4.5 Organic Ligand Complexation

Organic ligands are a likely component of the waste materials to be emplaced in the WIPP. Organic ligands have been shown to complex with actinides, which would increase the dissolved actinide concentrations in brine within the repository. However, organic ligands also complex strongly with multivalent metal cations. The result being that the multivalent metal cations will compete with actinides for complexation with the organic ligands. For the CRA-2004 PABC four organic ligands were included in the actinide solubility calculations: acetate, citrate, ethylenediaminetetraacetate (EDTA), and oxalate. These four ligands were chosen because they were the only water soluble organic ligands present in significant quantities in the waste (DOE 2004, Appendix SOTERM).

In the CRA-2004 PABC, solubility calculations were conducted to investigate the importance of organic ligand / actinide complex formation relative to  $\text{Mg}^{2+}/\text{Ca}^{2+}$ /organic ligand complexes. However, these calculations did not include the effects of other multivalent metal cations (such as  $\text{Fe}^{2+}$  and  $\text{Pb}^{2+}$ ). These calculations showed that the organic ligands will not form complexes with the +III and +IV actinides to a significant extent under expected WIPP conditions due to their strong affinity for complexing with  $\text{Mg}^{2+}$  and  $\text{Ca}^{2+}$ .

Because the stability constant of the other metal cation species are similar to those of  $\text{Ca}^{2+}$  and  $\text{Mg}^{2+}$  (Martell et al. 1998), the presence of dissolved  $\text{Fe}^{2+}$  and  $\text{Pb}^{2+}$  in any available brine will further reduce the availability of binding sites for actinides on the organic ligands. Thus the



increased amount of lead and iron placed in the repository due to shielded containers will further decrease the quantity of organic ligands available to form complexes with the actinides, which in turn should slightly reduce the solubilities of the actinides. The SCPA will use the baseline approach for modeling the impacts of organic ligands on actinide solubilities, since the solubilities would be reduced if this effect was included.

### 3.1.5 *Heterogeneity of Waste Placement*

A possible issue identified with the use of shielded containers is whether or not loading schemes and disposal schedules associated with the shielded containers could present inconsistencies with the baseline assumption of random waste emplacement. SNL staff have evaluated this concern and determined that the assumption of random waste emplacement is still valid for the SCPA. Their conclusions are based on the following discussion. Hansen et al. (2004) evaluated the impact of explicitly modeling heterogeneous waste distribution in PA results. Specifically, Hansen et al. (2004) examined two scenarios. The first scenario assumed that waste was emplaced randomly, as is assumed in the current WIPP PA technical baseline. The second scenario assumed that “waste is placed in contiguous blocks comprising single waste streams” (Hansen et al. 2004). Hansen et al. (2004) concluded that release mechanisms “are insensitive to uncertainty in the spatial arrangement of the waste... [and] thus, the assumption of random waste placement and the representation of waste as a homogenous materials remain appropriate.” Consequently, the SCPA used the baseline assumption that all waste is randomly emplaced.

### 3.1.6 *Repository Temperature*

For all WIPP performance assessments since the CCA, “the effects of temperature increases as a result of radioactive decay have been eliminated from PA calculations on the basis of low consequence to the performance of the disposal system” (DOE 2004, Appendix PA, Attachment SCR). The basis for the decision to screen out “heat from radioactive decay” (FEP number W13) is discussed in detail in Section SCR-6.2.1.2 of Appendix PA, Attachment SCR of the CRA-2004 (DOE 2004), and a brief summary of that section, as it applies to the SCPA, follows.

#### 3.1.6.1 *Temperature Analyses for RH-TRU Containers for the CCA*

Sanchez and Trelue (1996) conducted an analysis to calculate the thermal load of an RH-TRU canister and the maximum temperature rise in the immediate vicinity of the canister. To calculate the thermal load, Sanchez and Trelue (1996) did a set of inverse internal shielding calculations in which they identified the radiation source term corresponding to the maximum allowable surface dose rate (1,000 rem/hr) for RH-TRU canisters. “The ratio of the thermal load to the curie load was calculated to be about 0.0037 W/Ci. For a gamma source of  $2E+04$  Ci/m<sup>3</sup> (566 Ci/ft<sup>3</sup>), the maximum permissible thermal load of a RH-TRU container is about 70 W/m<sup>3</sup> (2 W/ft<sup>3</sup>). Thus, the maximum thermal load of a RH-TRU container is about 60 W because an RH-TRU container can hold 0.89 m<sup>3</sup> of waste when it is direct loaded (Section SCR-6.2.1.2 of Appendix PA, Attachment SCR, DOE 2004).

The second purpose of Sanchez and Trelue's (1996) analysis was to determine if there is any significant temperature rise near the surface of an RH-TRU container with the maximum allowable surface dose rate. Sanchez and Trelue (1996) used steady-state heat transfer calculations to demonstrate that there would not be a significant temperature rise. Specifically, they assumed a uniform heat generation source term in the container and that the container was surrounded by salt since the RH-TRU containers are loaded in boreholes in the walls of the waste rooms. Assuming a ratio of the thermal load to the curie load equal 0.0037 W/Ci, Sanchez and Trelue (1996) calculated that the maximum temperature increase at the surface of an RH-TRU container would be approximately 3° C, and the average temperature increase at the surface of an RH-TRU container would be less than 1° C. It should be noted that since the heat source on a container will actually decrease with time, use of steady state calculations yields a very conservative result and overestimates the actual temperature increase.

Djordjevic (2003) repeated the analysis of Sanchez and Trelue (1996) with the CRA-2004 inventory and determined that maximum temperature increase at the surface of an RH-TRU canister would be approximately 2° C, and the average temperature increase at the surface of an RH-TRU container would still be less than 1° C. The decrease in temperature increases is due to the fact that total heat load to total curie load ratio for the CRA-2004 decreased from the CCA values.

#### 3.1.6.2 Temperature Increases for Shielded Containers

The SCPA will use the same waste inventory that was used in the CRA-2004 PABC, and since the total heat load to total curie load ratio has decreased from the CCA, use of the CCA ratio in the following discussion is conservative.

A shielded container has an internal volume (30 gallons) that is less than one-seventh of the internal volume of the RH-TRU container (approximately 235 gallons). The SCPA is using the same RH TRU waste inventory from the CRA-2004 PABC, so the radionuclide content of the waste is the same as the CRA-2004 PABC inventory. Thus, the maximum thermal load for a shielded container with RH waste would be less than 8.5 W ( $60 \div 7$ ).

Furthermore, the walls of the shielded containers are much thicker than the walls of the RH-TRU container. The waste in RH-TRU containers is closer to the exterior surface of the container, and the heat must be conducted only through 0.25 in of steel (Figure 7). For the shielded containers, the heat must be conducted through a layer of 1 inch lead shielding and two steel layers that have a combined width of 0.3125 inch (Figure 7). Conservatively assuming that the waste in the shielded containers has the same thermal load to the curie load ratio (0.0037 W/Ci) as the value that Sanchez and Trelue (1996) used in their analysis, the significantly thicker walls of the shielded containers cause a smaller temperature increase at the surface of a shielded container than would be expected for a RH-TRU container. Consequently, the maximum temperature increase at the surface of a shielded container would still be less than 3° C. Furthermore, two objects in contact will reach a thermal equilibrium. That is, if two objects have different temperatures, they will reach a steady state equilibrium temperature that is less than the maximum temperature of the two objects and greater than the minimum temperature of the two

objects. Thus, even if multiple shielded containers are placed in contact with one another, the maximum temperature increase will still be less than 3° C. This temperature increase is considered insignificant in the current PA technical baseline. Therefore, the SCPA followed the baseline approach to modeling heat from radioactive decay. Specifically, the effects of temperature increases as a result of radioactive decay were eliminated from PA calculations on the basis of low consequence to the performance of the disposal system.

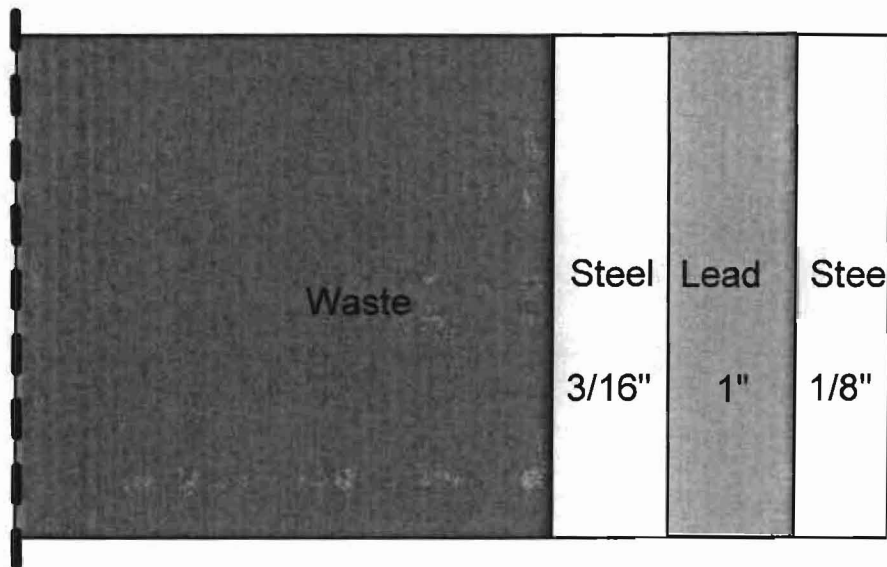

(a)

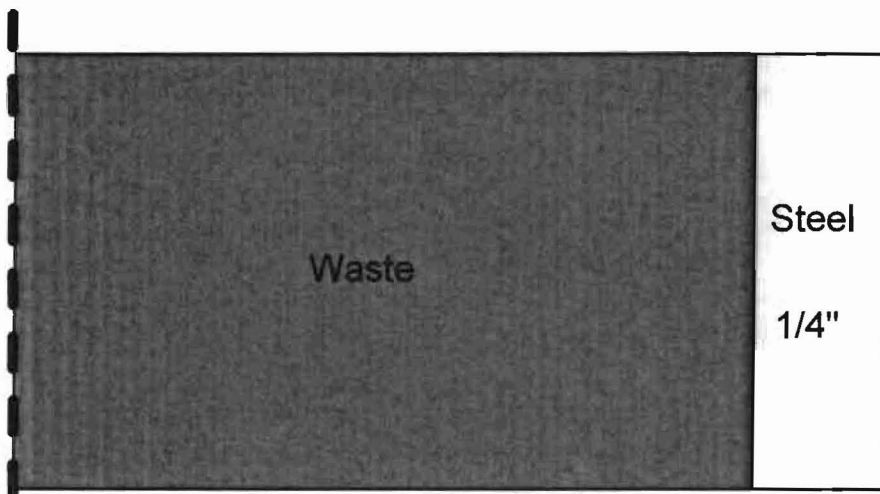

(b)

Figure 7. Partial Cross-Section of the (a) Shielded Container and (b) RH-TRU Container (Not to Scale).

3.1.7 Impact of Waste Location on Release Mechanisms

The WIPP PA code CCDFGF models the impact of drilling intrusions into the repository on radionuclide releases. In these calculations, the waste containing portions of the repository are

divided into two areas: one area that contains CH waste and one area that contains RH waste. When an intrusion occurs in a CH waste area, releases can occur from cuttings, cavings, spallings, direct brine releases (DBRs), or long-term releases. When an intrusion intersects the RH area, cuttings are the only mechanism for the releases of radionuclides. Little erosion is expected to occur near the drill bit for intrusions through RH waste (Table 9.2.1 of Helton et al. (1998)), so it is assumed that cavings releases do not occur when RH waste is intruded. "Due to the low permeability of the region surrounding each RH-TRU waste canister, intrusions into RH-TRU waste are assumed to not produce spallings releases" (Section 9.3 of Helton et al. (1998)). The same rationale is used to preclude the occurrence of DBRs for intrusions into RH waste. All of these assumptions are contingent upon the RH waste being placed in the RH-TRU canisters in the walls of the waste rooms. It should be noted that while DBRs and releases from groundwater transport do not occur for intrusions into RH waste areas, these releases are calculated using WIPP-scale data assuming homogeneous accessibility of RH- and CH-TRU waste activities by liquid in the repository.

Since shielded containers will be emplaced in areas containing CH waste, this waste could possibly be accessible to cavings and spallings (in addition to cuttings, DBRs, and long term releases) since the permeability in the CH waste areas is expected to be substantially higher than permeability of the salt in the walls. Thus, the SCPA included the possibility that cavings, spallings, and direct brine releases (in addition to cuttings releases) could occur if a borehole intruded an area with shielded containers.

### 3.1.8 Impact of Shielded Containers on Release Mechanisms

During the review of the CRA-2004, the EPA asked the DOE to assess the impact of container variability on releases, specifically spallings releases (Vugrin 2004). The DOE responded that

*"the addition of new container types do not impact calculated spall releases (or cuttings and cavings) because PA conservatively assumes that the containers are not present. In Appendix PA, Attachment SCR, both features, events, and processes (FEPs) associated with container type (W4 Container Form and W34 Container Integrity) are screened out due to beneficial consequences. That is, the containers are assumed to instantaneously fail, making the waste material immediately available to cuttings, cavings, spallings, or other transport and release mechanism. The emplacement of additional container types in the repository can only impact the performance of the WIPP if it is assumed that they maintain some of their structural integrity. In the case of spallings, a robust container that would persist over time would at least delay or decrease the movement of radionuclides towards the intrusion borehole, and may, in an extreme case, isolate the waste material from spalling altogether. In either case, the releases would decrease if the physical properties of waste containers were included in performance assessment calculations. Because PA takes no credit due to the physical aspects of the container, container variability does not impact calculated spall releases"* (Vugrin 2004).

Consistent with the FEPs basis, while the shielded containers are expected to be more durable than the standard 55-gallon drums, the SCPA followed the baseline FEPs screening decisions and did not take credit for the physical aspects of the shielded containers. Thus, the mechanical properties of the containers will not affect PA predictions. This is considered to be a conservative assumption.

### *3.1.9 Location of RH Waste Streams*

For the CRA-2004 PABC one composite waste stream was used to represent the RH waste, and the activity of this waste stream is determined by taking a volume-weighted average of all 77 RH waste streams. RH waste comprises less than 3% of the total EPA Units in the repository, in the current baseline inventory. Because of this low contribution to the total EPA Units one RH waste stream is used in the same manner as in the CCA (EPA 1998, Section 6.4.12.4). It was also assumed that all RH waste would be emplaced in the walls of the disposal rooms.

The SCPA included a set of waste emplacement scenarios that were designed to assess the impact of the use of shielded containers. They are as follows:

1. In the SCPA scenario 1, no RH waste is placed in shielded containers, and all RH waste is emplaced in the walls of the waste rooms. This RH loading scenario is precisely the same that was used for the CRA-2004 PABC, so the results of that analysis will be used to represent repository performance in this scenario.
2. In the second SCPA scenario, all RH waste is packaged in shielded containers, and all RH waste is placed on the floors of the waste rooms. New calculations were performed to assess repository performance in this scenario.
3. In SCPA scenario 3, half of the RH waste is packaged in shielded containers and placed on the floors of the disposal rooms, and the other half of the RH waste is packaged in RH-TRU waste canisters and emplaced in the walls of the disposal rooms. New calculations were performed to assess repository performance in this scenario.

These scenarios were designed to determine if releases were sensitive to the location of the RH waste by performing two extreme bounding scenarios (all in the walls or all on the floor) and an intermediate scenario (half on the floor and half in the walls). In reality, DOE is going through a screening process to determine which waste streams are eligible to be packaged in shielded containers. The results of this screening process will determine the operational approach, with some fraction of the RH waste streams being placed in shielded containers and the remainder in the walls. The scenarios described above span the full range of operational possibilities, but do not reflect DOE's actual emplacement plan for RH waste. In all three of these scenarios, a single, composite waste stream was used to represent the RH waste.

To assure that one composite waste stream remains appropriate, we conducted a scenario with 77 individual RH waste streams. Thus, SCPA scenario 2 calculations described above were redone with explicit representation of the 77 individual RH waste streams. (This calculation is referred to as SCPA scenario 4, henceforth.) The purpose of this calculation was to demonstrate that

releases are not significantly affected by the representation of RH waste as a single, “average” waste stream.

*3.1.10 Summary of SCPA Implementation Issues*

The previous subsections discussed possible implementation issues for the SCPA. Table 8 lists all of those issues and how the SCPA will manage those issues.

**Table 8. SCPA Approach to Modeling Issues Listed in Table 6.**

<b>Issue</b>	<b>Section</b>	<b>SCPA</b>
Contents of waste materials	3.1.1	DOE does not propose to modify the waste materials that will be emplaced in the WIPP, so the SCPA will use the waste inventory and mechanical parameters from the CRA-2004 PABC since they will not be affected by the use of shielded containers.
Emplacement and container materials	3.1.2	The SCPA will use the CRA-2004 PABC emplacement parameters for steel and CPR materials since the small change to these quantities caused by the use of shielded containers will not significantly affect repository performance.
Room closure	3.1.3	The SCPA will use the CRA-2004 PABC porosity surfaces that were calculated with the Standard Waste Model since repository performance is relatively insensitive to the structural rigidity of waste and waste containers.
Chemical conditions	3.1.4	Because the presence of lead is expected to have a generally beneficial effect on chemical conditions and decrease actinide solubilities, the SCPA will conservatively use the CRA-2004 PABC actinide solubilities that were calculated without explicitly including the effects of lead.
Heterogeneity of waste placement	3.1.5	The SCPA will assume that the stacks of CH and shielded containers are randomly distributed since mean releases are insensitive to uncertainty in the spatial arrangement of the waste.
Repository Temperature	3.1.6	The use of shielded containers does not affect any baseline assumptions pertaining to repository temperatures, so the SCPA will not make any modifications to these baseline assumptions.
Impact of waste location on release mechanisms	3.1.7	The SCPA will assume that RH waste in shielded containers is accessible to all release mechanisms.
Impact of shielded containers on release mechanisms	3.1.8	The SCPA will follow the baseline approach of assuming that all waste containers instantly fail,

		so the SCPA will conservatively not take credit for the physical properties of the shielded containers.
Location of RH waste streams	3.1.9	The SCPA will model RH emplacement with three scenarios: <ol style="list-style-type: none"> <li>1. All RH waste in the walls;</li> <li>2. All RH waste on the floor; and</li> <li>3. Half of the RH waste in the wall and half of the RH waste on the floors;</li> </ol> These three scenarios will use a single, "average" RH waste stream. One additional calculation will model all 77 individual RH waste streams on the floor.

**3.2 Development of the Analysis Design**

The SCPA analysis seeks to answer the following question: How is long-term repository performance affected by emplacement of RH waste in shielded containers? To isolate the impact of the use of shielded containers, the SCPA was designed to deviate as little as possible from the CRA-2004 PABC. As discussed in Section 3.1 and its subsections, the only baseline parameters and assumptions that needed to be modified to represent the emplacement of RH waste in shielded containers were those parameters and assumptions related to the location of RH waste. No other parameters or assumptions from the CRA-2004 PABC needed to be modified. Consequently, the only PA codes that needed to be run for the SCPA were those codes related to the execution of CCDFGF and EPAUNI. The CCDFGF code determines the consequences of the releases for the various scenarios and EPAUNI calculated radionuclide decay. These codes were rerun as necessary for the SCPA scenarios described in Section 3.1.9.

The process used for conducting the SCPA can be broken down into four steps:

1. Identify how the use of these containers affects WIPP PA technical baseline assumptions and implementation of PA models (Section 3.1).
2. Make necessary modifications to baseline assumptions and the implementation of PA models.
3. Execute numerical codes for the SCPA.
4. Analyze and document the results.

The following subsections detail the approach that the SCPA used.

**3.3 Parameters Development**

The SCPA calculations required the creation of new parameters used by the code CCDFGF. The new parameters are defined and calculated in Dunagan (2007b). The new parameters represent the fraction of repository volume occupied by waste and the area for RH waste disposal in the walls of the repository. Table 9 lists the new parameters and their values that were created for the SCPA. These parameters were used in the place of REFCON:FVW and

REFCON:AREA\_RH since REFCON:FVW and REFCON:AREA\_RH were calculated assuming that all RH waste would be placed in the walls.

**Table 9 Parameters Created for the SCPA.**

MATERIAL	PROPERTY	VALUE (UNITS)	DESCRIPTION
REFCON	FVW_ALLRH	0.402 (none)	Fraction of repository volume occupied by CH and RH waste in CCDFGF model (Scenario 2).
REFCON	FVW_HALFRH	0.394 (none)	Fraction of repository volume occupied by CH waste and half of total RH waste in CCDFGF model (Scenario 3).
REFCON	AREA_NORH	0 (m <sup>2</sup> )	Area for RH waste disposal in CCDFGF model when all RH waste is included with CH waste on repository floors (Scenario 2).
REFCON	AREA_HAFRH	7.880e3 (m <sup>2</sup> )	Area for RH waste disposal in CCDFGF model when half of total RH waste is included with CH waste on repository floors (Scenario 3).

**3.4 Execution of WIPP PA Codes**

APPENDIX B: RUN CONTROL contains all of the code execution and run control information for the SCPA.

**3.5 Analysis of Results**

The CRA-2004 PABC results represent the repository performance using baseline assumptions and parameters (scenario 1). The results of SCPA scenarios 2 and 3 were compared with the CRA-2004 PABC results to assess the potential impacts of shielded containers on repository performance. The results from the SCPA scenarios 2 and 4 were compared to assess the sensitivity of the explicit representation of individual waste streams on releases. For each set of comparisons, complementary cumulative distribution functions (CCDFs) were evaluated.

**3.6 Deviations from AP-135**

There were four deviations from the analysis plan, AP-135. One deviation was the container design. Figure 3 in AP-135 showed a preliminary design of the shielded container. This final design increased the thickness of the steel lid and bottom from 2.75” to 3”. This change was captured in the steel estimates (Crawford and Taggart 2007) and can be seen in Figure 3 of this document.



The second deviation from AP-135 was the addition of more calculations to assess the impact of RH waste on releases. CCDFGF was rerun using the CRA-2004 PABC files (Leigh et al. 2005a) with the fraction of repository volume occupied by waste (REFCON:FVW) set equal to zero. By setting this parameter equal to zero the contribution from cuttings, cavings, and spillings releases from CH waste were eliminated from the total release results. This permits the evaluation of RH waste's impacts on total releases because the current baseline only attributes RH cuttings releases to the total releases results (see Section 3.1.7). Therefore, the cuttings output of this set of calculations represent the total releases from RH waste. The results of this calculation are shown in Section 2.3.

The third deviation from AP-135 is that additional qualified codes that were not explicitly called out in AP-135 were used in the SCPA calculations (see Table B. 1). These additional codes were used to capture the parameter changes that were required for the analysis.

Finally, as described in AP-132, DOE was considering proposing a set of changes to the WIPP PA technical baseline (Vugrin and Nemer 2007). AP-135 indicated that a set of calculations would be performed to determine if the use of shielded containers would affect estimates of repository performance in the event that the proposed PA changes were incorporated into the technical baseline. Those calculations were performed, but this document does not include an analysis of those results. DOE has decided not to continue with the peer review of the proposed PA changes, so they will not become a part of the WIPP PA baseline at this time.

## 4 RESULTS

This section presents total normalized releases for the SCPA scenarios, with a discussion of the cuttings and cavings, spillings, and direct brine releases. Specifically, the mean complementary cumulative distribution functions (CCDFs) for replicate 1 of these release mechanisms are presented herein. The releases through groundwater transport for all scenarios were insignificant, as in the CRA-2004 PABC (Leigh et al. 2005a) and will not be evaluated further in this report.

SCPA scenario 2 was run for three replicates while scenarios 3 and 4 were run for one replicate. The trends observed for replicate 1 comparisons hold for replicates 2 and 3, as well, so they are not shown in this section. The mean CCDFs for replicates 2 and 3 of scenario 2 are shown in APPENDIX A: ADDITIONAL FIGURES.

In Section 4.1 the results of the SCPA scenarios 2 and 3 are compared to the CRA-2004 PABC to determine if modeling the packaging of RH waste in shielded containers affects baseline estimates of releases. In Section 4.2 the results of SCPA scenarios 2 and 4 are compared to determine if the explicit representation of RH waste streams yields significantly different results from calculations that model RH waste with a single composite waste stream.

### 4.1 Comparison of Scenarios 2 and 3 to the CRA-2004 PABC

The results of the SCPA scenario 2 represent the long-term repository performance when all of the RH waste is placed in shielded containers on the floor of the repository. The results of the

SCPA scenario 3 represent the long-term repository performance when half of the RH waste is placed in shielded containers on the floor of the repository and the remaining half is placed in canisters in the walls of the repository. When SCPA scenarios 2 and 3 are compared to the results of the CRA-2004 PABC, the effects of the location of the RH waste can be evaluated.

Figure 8, Figure 9, Figure 10, and Figure 11 compare mean CCDFs for total, cuttings and cavings, spillings, and DBR normalized releases, respectively, for replicate 1 of SCPA scenarios 2 and 3 and the CRA-2004 PABC. The mean CCDFs for total, cuttings and cavings, and spillings releases are virtually indistinguishable between SCPA scenarios and the CRA-2004 PABC.

In addition, the mean DBR CCDFs have no significant differences between SCPA scenarios and the CRA-2004 PABC, either. However, mean DBRs for SCPA scenario 2 are consistently the smallest, and the mean DBRs for the CRA-2004 PABC are consistently the largest. The frequency and magnitude of DBRs are typically highest when a brine pocket has previously been intruded since the additional brine that enters the repository in these scenarios generally result in high pressures and brine saturations, conditions leading to DBRs. Thus, the trend in DBRs can be explained by evaluating the probability of hitting a brine pocket. Given that an intrusion intersects the berm area, the conditional probability that a borehole penetrates a Castile brine pocket is the product of two factors:  $P(E|B)$ , the conditional probability that excavated area is intruded given that the berm area is intersected, and the sampled GLOBAL:PBRINE value. The CRA-2004 PABC and SCPA scenarios used identical sampled GLOBAL:PBRINE values, so the trend in mean DBRs is caused by the differences in  $P(E|B)$ .  $P(E|B)$  is defined to be the sum of the RH and CH excavated areas, divided by the berm area.

$$P(E|B) = \frac{\text{CH Area} + \text{RH Area}}{\text{Berm Area}} \quad (6)$$

The CH excavated area is defined to be  $1.12\text{e}5 \text{ m}^2$  (REFCON:AREA\_CH), and the berm area (repository footprint) is  $6.29\text{e}5 \text{ m}^2$  (REFCON:ABERM). The RH area is the only term that varies, and Table 10 lists the RH areas for the three calculations. Since the CRA-2004 PABC has the largest RH area, the probability of intersecting a brine pocket (when the berm area is intersected) is highest for the CRA-2004 PABC, and, consequently, the CRA-2004 PABC resulted in the largest mean DBRs. Similarly, SCPA scenario 2 had the lowest DBRs since that calculation used the smallest RH area.

It should be restated that even though the CRA-2004 PABC had the largest mean DBRs at all probabilities, the difference between the DBRs for the CRA-2004 PABC and the SCPA scenarios were still extremely small and not large enough to discernibly impact mean total releases.

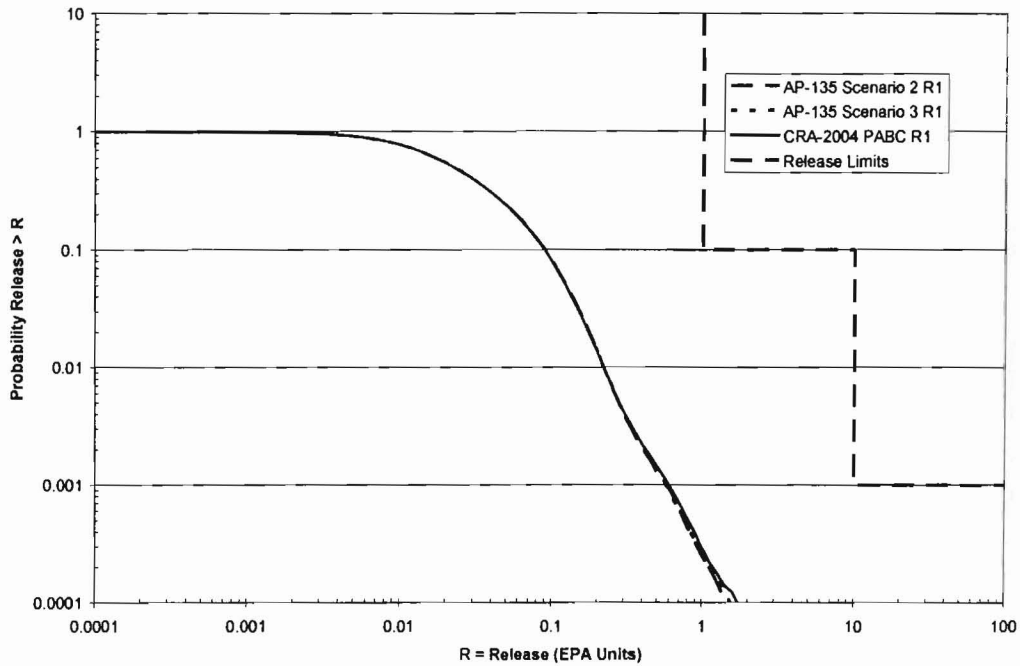

Figure 8. Mean Total Releases from SCPA Scenarios 2 and 3 and CRA-2004 PABC, Replicate 1.

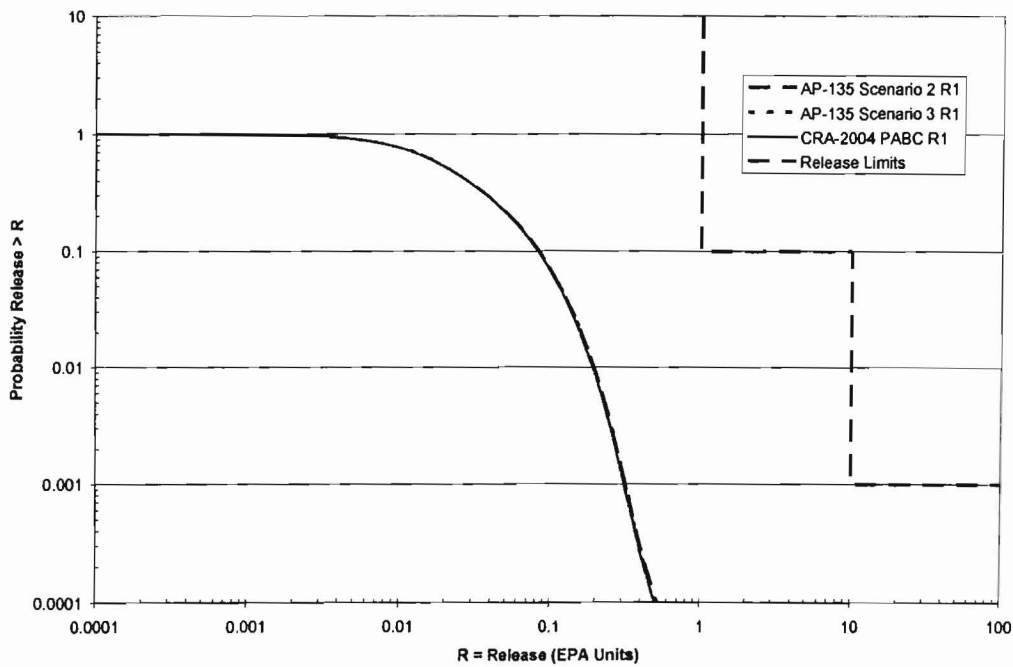

Figure 9. Mean Cuttings and Cavings Releases from SCPA Scenarios 2 and 3 and CRA-2004 PABC, Replicate 1.

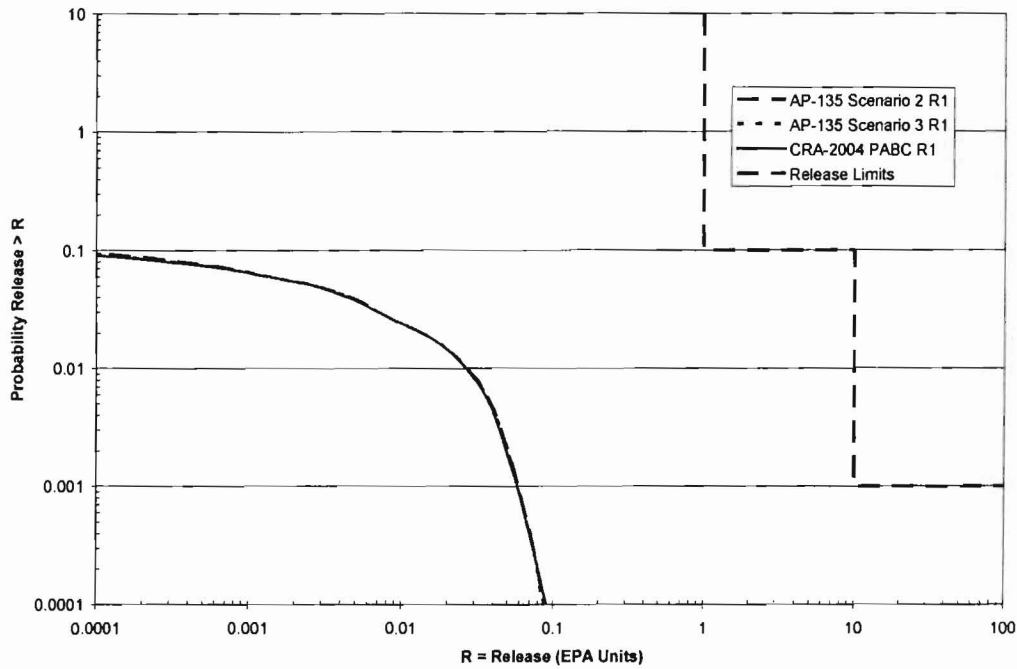

Figure 10. Mean Spallings Releases from SCPA Scenarios 2 and 3 and CRA-2004 PABC, Replicate 1.

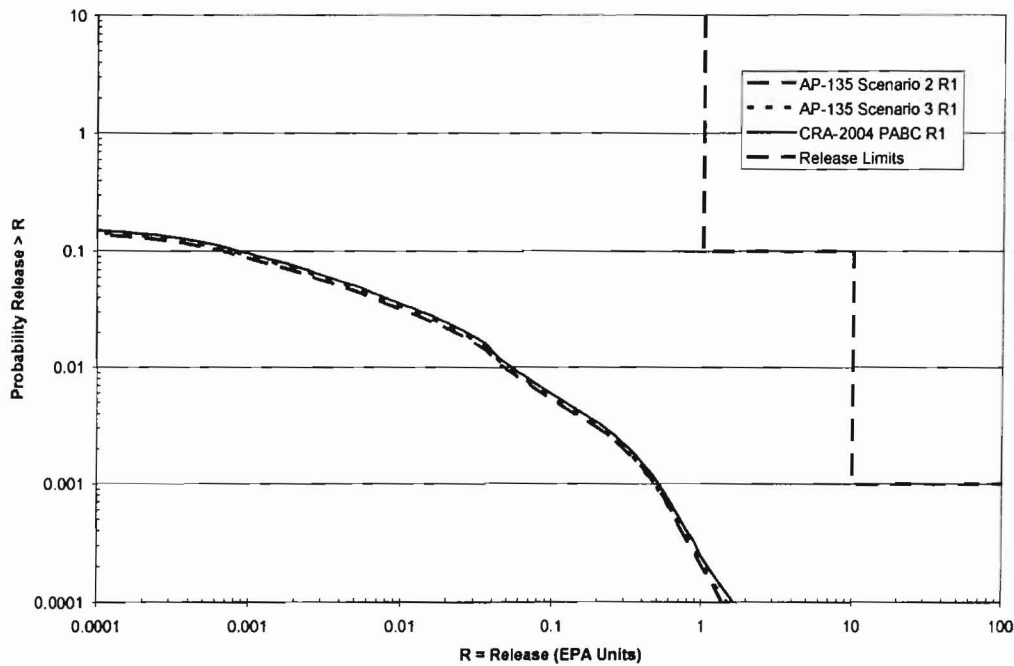

Figure 11. Mean DBRs from SCPA Scenarios 2 and 3 and CRA-2004 PABC, Replicate 1.

**Table 10. RH Areas for the CRA-2004 PABC and SCPA Scenarios 2 and 3.**

Calculation	RH Area (m <sup>2</sup> )	Material	Property
SCPA Scenario 2	0	REFCON	AREA_NORH
SCPA Scenario 3	7880	REFCON	AREA_HAFRH
CRA-2004 PABC	15760	REFCON	AREA_RH

**4.2 Comparison of Scenario 2 to Scenario 4**

The results of the SCPA scenario 2 and scenario 4 are compared to determine the impact on releases when RH waste is modeled with two different approaches. SCPA scenario 2 calculations use a single RH waste stream to represent all RH waste streams while SCPA scenario 4 calculations explicitly represent all of the 77 individual RH waste streams. There are no other differences between the two calculations.

Figure 12 compares the distribution of total normalized releases for SCPA scenario 2 to SCPA scenario 4, replicate 1. Modeling the use of shielded containers with explicit representation of all 77 individual RH waste streams caused no differences of practical significance on the mean releases.

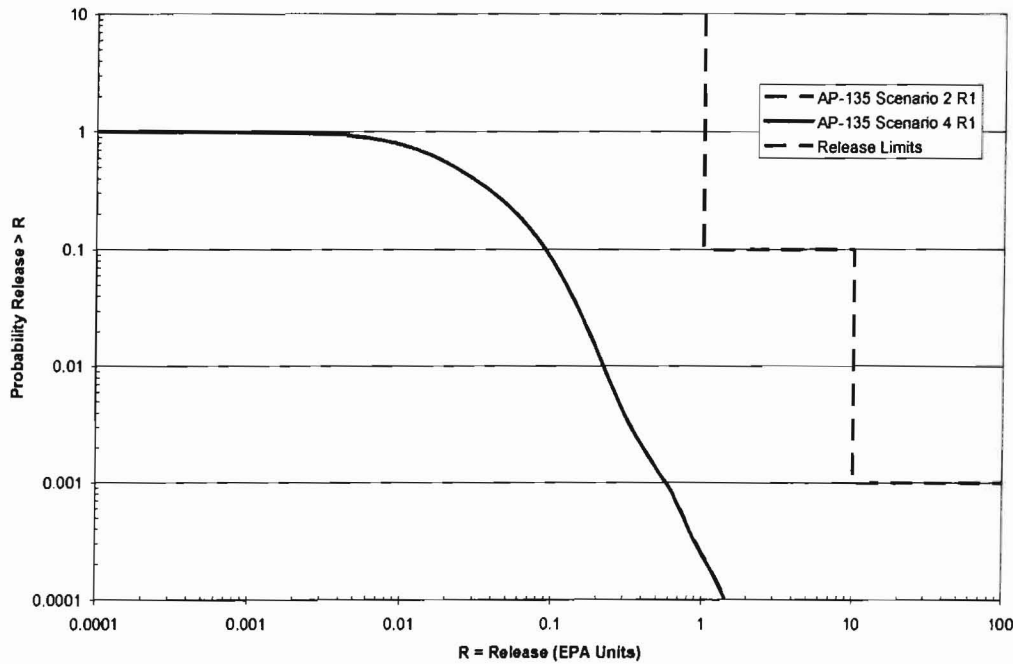

**Figure 12. Mean Total Releases from SCPA Scenario 2 and Scenario 4, Replicate 1.**

## 5 SUMMARY AND CONCLUSIONS

PA is the primary tool used by DOE to demonstrate compliance with the long-term disposal regulations in 40 CFR 191 (Subparts B and C) and the compliance criteria in 40 CFR 194. Previous PAs have used the assumption that all RH waste would be emplaced in canisters in the walls of the repository. DOE is proposing the use of a shielded container for the emplacement of RH waste. This shielded container would be placed on the floor of the repository in a manner similar to that used for CH waste disposal. DOE tasked SNL to assess the impact of emplacing RH waste in shielded containers on the long term performance of the repository by conducting a performance analysis using the current baseline PA system, making only those changes necessary to represent shielded containers in the WIPP.

The specific approach used in this analysis involved five steps:

1. Evaluate WIPP PA baseline assumptions, models, and parameters to determine which are affected by the use of shielded containers;
2. Develop an analysis design to incorporate necessary modifications to the baseline approach;
3. Develop necessary parameters for the SCPA;
4. Execute WIPP PA codes; and
5. Conduct an analysis of results, including a comparison with baseline predictions of long term repository performance.

The review of baseline assumptions determined that the primary modification that needed to be made to the WIPP PA baseline assumptions was the re-location of the RH waste from the boreholes in the walls of the repository to the floor of the repository. This would also require the creation of new parameters to represent this change in certain PA models. The new parameters would represent the fraction of repository volume occupied by waste and the area for RH waste disposal in the walls of the repository for scenarios that model the inclusion of shielded containers. It was determined that no other changes to the baseline were necessary to represent the presence of shielded containers.

Due to uncertainty pertaining to the quantity of RH waste that could be emplaced in shielded containers, the SCPA used a bounding approach to model what waste would be packaged in shielded containers. The baseline scenario was the CRA-2004 PABC where the RH waste is all located in the walls of the repository, emplaced in canisters. SCPA scenario 2 assumed that all of the RH waste would be emplaced in shielded containers, located on the floor of the repository. No other changes were made to the baseline approach for this scenario. SCPA scenario 3 assumed that half of the RH waste would be emplaced in shielded containers located on the floor of the repository and half of the RH waste would be emplaced in canisters located in the walls of the repository. No other changes were made to the baseline approach for this scenario. A comparison of the results from SCPA scenario 2 and SCPA scenario 3 to the CRA-2004 PABC results identified the effects on releases of the emplacement of shielded containers in the repository on the current baseline.

In the CRA-2004 PABC (and SCPA scenarios 2 and 3), a single, composite waste stream was used to represent all of the RH waste. SCPA scenario 4 is a repeat of SCPA scenario 2, with the exception that the 77 individual waste streams are explicitly represented instead of using a single average waste stream to represent the RH waste. A comparison of the results from SCPA scenarios 2 and 4 identified the effects of using an average RH waste stream to represent all RH waste.

This analysis concludes that the WIPP continues to comply with the containment requirements specified in 40 CFR 191.13 when representing the disposal of RH waste in shielded containers. Analysis results with shielded containers are not discernibly different than the results of the current compliance baseline. Moreover, this analysis concludes that the packaging and emplacement of RH waste in shielded containers has no discernable impact on releases. This statement applies to all release pathways: cuttings and cavings, spillings, direct brine releases, groundwater releases, and total releases. Furthermore, the explicit representation of individual RH waste streams is not warranted since the representation of RH waste with a single, composite RH waste stream does not result in discernibly different results than when individual RH waste streams are used.

## 6 REFERENCES

- Barnhart, C.L., and Vestal, R. 1983. "Effect of Environmental Toxicant on Metabolic Activity of Natural Microbial Communities", *Applied and Environmental Microbiology*. Vol. 46, 970-977.
- Brush, L. H., and G. T. Roselle. 2006. Geochemical Information for Calculation of the MgO Excess Factor. Memo to Eric D. Vugrin, November 17, 2006. Sandia National Laboratories. Carlsbad, NM. ERMS 544840.
- Capone, D.G., Reese, D.D., and Kiene, R.P. 1983. "Effects of Metals on Methanogenesis, Sulfate Reduction, Carbon Dioxide Evolution, and Microbial Biomass in Anoxic Salt Marsh Sediments", *Applied and Environmental Microbiology*. Vol. 45, 1586-1591.
- Cotsworth, E. 2005. EPA Letter on Conducting the Performance Assessment Baseline Change (PABC) Verification Test. U.S. EPA, Office of Radiation and Indoor Air, Washington, D.C. ERMS 538858.
- Crawford, B.A. 2005a. "Waste Material Densities in TRU Waste Streams from TWBID Revision 2.1 Version 3.13, Data Version D.4.15". Analysis Report, April 13, 2005. Carlsbad, NM: Los Alamos National Laboratory. ERMS 539323.
- Crawford, B.A. 2005b. "Tables Containing Lead Data from TWBID Rev. 2-1 D.4.15". Memorandum to J. Trone, October 20, 2005. Carlsbad, NM: Los Alamos National Laboratory. ERMS 541735.
- Crawford, B., and Taggart, D. 2007. Analysis of RH TRU wastes for Containment in Lead Shielded Containers. Los Alamos National Laboratory Carlsbad Operations, Simple Analysis Report INV-SAR-08, Rev 0.
- Djordjevic, S. 2003. Estimation of Maximum RH-TRU Thermal Heat Load for WIPP for Compliance Recertification Application, Rev. 1. Sandia National Laboratories, Carlsbad, NM. ERMS 531593.
- DOE (U.S. Department of Energy). 1988. Radioactive Waste Management, Order 5820.2A. Washington, D.C.
- DOE. 1995. Remote-Handled Transuranic Waste Study; DOE/CAO-1095, DOE Carlsbad Field Office. Carlsbad, NM.
- DOE. 1996. Title 40 CFR Part 191 Compliance Certification Application for the Waste Isolation Pilot. DOE/CAO-1996-2184, U.S. Department of Energy Waste Isolation Pilot Plant, Carlsbad Area Office, Carlsbad, NM.



DOE. 2004. Title 40 CFR Part 191 Compliance Recertification Application for the Waste Isolation Pilot Plant, DOE/WIPP 2004-3231, 10 vols., US Department of Energy, Carlsbad Field Office, Carlsbad, NM.

DOE. 2006a. Remote Handled Transuranic Waste Authorized Methods of Payload Control (RH-TRAMPAC), Rev. 0. DOE/WIPP 90-045 Rev. 7. RH-TRAMPAC Document Rev.0, June 2006. US Department of Energy, Carlsbad Field Office, Carlsbad, NM.

DOE. 2006b. Transuranic Baseline Inventory Report – 2004, US Department of Energy, Carlsbad Field Office, Carlsbad, NM. DOE/TRU-2006-3344.

DOE. 2007. First Remote-Handled Transuranic Waste Shipment arrives at WIPP. DOE News, January 24, 2007, 03DR0107. US Department of Energy, Carlsbad Field Office, Carlsbad, NM.

Dunagan, S. C., C. W. Hansen, and W. P. Zelinski. 2005. Effect of Increasing Cellulosics, Plastics, and Rubbers on WIPP Performance Assessment, Revision 1. Sandia National Laboratories, Carlsbad, NM. ERMS 538445.

Dunagan, S.C. 2007a. Sandia's Inventory Data Needs For Shielded Container Performance Assessment. Sandia National Laboratories, Carlsbad, NM. ERMS 546359.

Dunagan, S.C. 2007b. New Parameters for AP-135. Memorandum August 27, 2007. Sandia National Laboratories, Carlsbad, NM. ERMS 546765.

Dunagan, S.C. and Vugrin, E.D. 2007. Analysis Plan to Assess the Impact of Shielded Container Emplacement in the Waste Isolation Pilot Plant, AP-135. Sandia National Laboratories, Carlsbad, NM. ERMS 546628.

EPA (U.S. Environmental Protection Agency). 1998. 40 CFR 194, Criteria for the Certification and Recertification of the Waste Isolation Pilot Plant's Compliance with the Disposal Regulations: Certification Decision: Final Rule, Federal Register. Vol. 63, 27354-27406. ERMS 251924.

EPA. 2006. 40 CFR 194, Criteria for the Certification and Recertification of the Waste Isolation Pilot Plant's Compliance With the Disposal Regulations: Recertification Decision. Vol. 71, Bo. 68, 18010.

Hansen, C. W., L. H. Brush, M. B. Gross, F. D. Hansen, B.-Y. Park, J. S. Stein, and T. W. Thompson. 2004. Effects of Supercompacted Waste and Heterogeneous Waste Emplacement on Repository Performance. Sandia National Laboratories, Carlsbad, NM. ERMS 533551.

Helton, J.C., Bean, J.E., Berglund, J.W., Davis, F.J., Economy, K., Garner, J.W., Johnson, J.D., MacKinnon, R.J., Miller, J., O'Brien, D.G., Ramsey, J.L., Schreiber, J.D., Shinta, A., Smith, L.N., Stoelzel, D.M., Stockman, C., and Vaughn, P. 1998. Uncertainty and Sensitivity Analysis

Results Obtained in the 1996 Performance Assessment for the Waste Isolation Pilot Plant. Sandia National Laboratories. SAND98-0365.

Konopka, A., Zakharova, T., Bischoff, M., Oliver, L., Nakatsu, C., and Turco, R.F. 1999. "Microbial Biomass and Activity in Lead-Contaminated Soil", *Applied and Environmental Microbiology*. Vol. 65, 2256-2259.

Leigh, C. D. and Trone, J.R. 2005. Calculation of the Waste Unit Factor For the Performance Assessment Baseline Calculation, Rev. 0. Sandia National Laboratories. Carlsbad, NM. ERMS 539613.

Leigh, C. D., J. F. Kanney, L. H. Brush, J. W. Garner, G. R. Kirkes, T. Lowry, M. B. Nemer, J. S. Stein, E. D. Vugrin, S. Wagner, and T. B. Kirchner. 2005a. 2004 Compliance Recertification Application Performance Assessment Baseline Calculation, Revision 0. Sandia National Laboratories, Carlsbad, NM. ERMS 541521.

Leigh, C. D., J. R. Trone and B. Fox 2005b. TRU Waste Inventory for the 2004 Compliance Recertification Application Performance Assessment Baseline Calculation. Sandia National Laboratories, Carlsbad, NM. ERMS 541118.

MacKinnon, R. J., and G. Freeze. 1997a. Summary of EPA-Mandated Performance Assessment Verification Test (Replicate 1) and Comparison With the Compliance Certification Application Calculations, Revision 1. Sandia National Laboratories, Carlsbad, NM. ERMS 422595.

MacKinnon, R. J., and G. Freeze. 1997b. Summary of Uncertainty and Sensitivity Analysis Results for the EPA-Mandated Performance Assessment Verification Test, Rev. 1. Sandia National Laboratories, Carlsbad, NM. ERMS 420669.

MacKinnon, R. J., and G. Freeze. 1997c. Supplemental Summary of EPA-Mandated Performance Assessment Verification Test (All Replicates) and Comparison With the Compliance Certification Application Calculations, Revision 1. Sandia National Laboratories, Carlsbad, NM. ERMS 414880.

Marcinowski, F. 2003. Environmental Protection Agency (EPA) Preliminary Review of Information for the Advanced Mixed Waste Treatment Project (AMWTP). U.S. Environmental Protection Agency, Washington, D.C. ERMS 532413.

Marcinowski, F. 2004. Environmental Protection Agency: Letter to R. Paul Detwiler on March 26, 2004 from Frank Marcinowski Approving the Disposal of Compressed Transuranci Waste From the AMWTF at the WIPP. U.S. environmental Protection agency, Washington, D.C. ERMS 534327.

Martell, A.E., Smith, R.M., and Motekaitis, R.J. 1998. *NIST Critically Selected Stability Constants of Metal Complexes Database, Version 5.0*. NIST Standard Reference Database 46. ERMS 506474.

Nemer, M.B. 2007. Effects of Not Including Emplacement Materials in CPR Inventory on Recent PA Results. Sandia National Laboratories. Carlsbad, NM. ERMS 545689.

Nieto, J.J., Fernandez-Castillo, R., Marquez, M.C., Ventosa, A., Quesada, E., and Ruiz-Berraquero, F. 1989. "Survey of Metal Tolerance in Moderately Halophilic Eubacteria", *Applied and Environmental Microbiology*. Vol. 55, 2385-2390.

Park, B.Y. and F.D. Hansen. 2003. Determination of the Porosity Surfaces of the Disposal Room Containing Various Waste Inventories for the WIPP PA. Sandia National Laboratories. Albuquerque, NM. ERMS 533216.

Roane, T.M. 1999. "Lead Resistance in Two Bacterial Isolates from Heavy Metal-Contaminated Soils", *Microbial Ecology*. Vol. 37, 218-224.

Said, W.A. and Lewis, D.L. 1991. "Quantitative Assessment of the Effects of Metals on Microbial Degradation of Organic Chemicals", *Applied and Environmental Microbiology*. Vol. 57, 1498-1503.

Sanchez, L.C., and Trelue, H.R. 1996. Estimation of Maximum RH-TRU Thermal Heat Load for WIPP. Memo to T. Hicks (Galson Sciences Ltd.), January 17, 1996. Sandia National Laboratories, Albuquerque, NM. ERMS # 231165

Sellmer, T. 2007. Final Container Design, Shielded Container. Washington TRU Solutions, Carlsbad, NM. ERMS 547052.

U.S. Congress. 1992. Waste Isolation Pilot Plant Land Withdrawal Act. Public Law 102-579, October 1992. 102nd Congress, Washington, D.C.

Vugrin, E.D. 2004. CRA Response Activity, Tracking Number 05/20/04Y, Response to EPA Question C-23-10, Revision 1. Sandia National Laboratories, Carlsbad, NM. ERMS 538112.

Vugrin, E. D., and Nemer, M. B. 2007. Analysis Plan for the 2009 Compliance Recertification Application Performance Assessment. Sandia National Laboratories, Carlsbad, NM. ERMS 545496.

Wall, N.A. and D. Enos. 2006. Iron and Lead Corrosion in WIPP-Relevant Conditions, TP 06-02, Rev. 1. Sandia National Laboratories, Carlsbad, NM. ERMS 543238.

Wilson, C., D. Porter, J. Gibbons, E. Oswald, G. Sjoblom, and F. Caporuscio. 1996a. Conceptual Models Peer Review Report, U.S. Department of Energy, Carlsbad Area Office, Office of Regulatory Compliance, July 1996. ERMS 241805.

Wilson, C., D. Porter, J. Gibbons, E. Oswald, G. Sjoblom, and F. Caporuscio. 1996b. Conceptual Models Supplementary Peer Review Report, U.S. Department of Energy, Carlsbad Area Office, Office of Regulatory Compliance, December 1996. ERMS 243153.

Wilson, C., D. Porter, J. Gibbons, E. Oswald, G. Sjoblom, and F. Caporuscio. 1997a. Conceptual Models Second Supplementary Peer Review Report, U.S. Department of Energy, Carlsbad Area Office, Office of Regulatory Compliance, January 1997.

Wilson, C., D. Porter, J. Gibbons, E. Oswald, G. Sjoblom, and F. Caporuscio. 1997b. Conceptual Models Third Supplementary Peer Review Report, U.S. Department of Energy, Carlsbad Area Office, Office of Regulatory Compliance, April 1997. ERMS 510790.

Zucconi, L., Ripa, C., Alianiello, F., Benedetti, A., and Onofri, S. 2003. "Lead Resistance, sorption and accumulation in a *Paecilomyces lilacinus* strain", *Biology and Fertility of Soils*. Vol. 37, 17-22.

**APPENDIX A: ADDITIONAL FIGURES**

This appendix contains additional figures containing CCDFs from SCPA scenario 2.

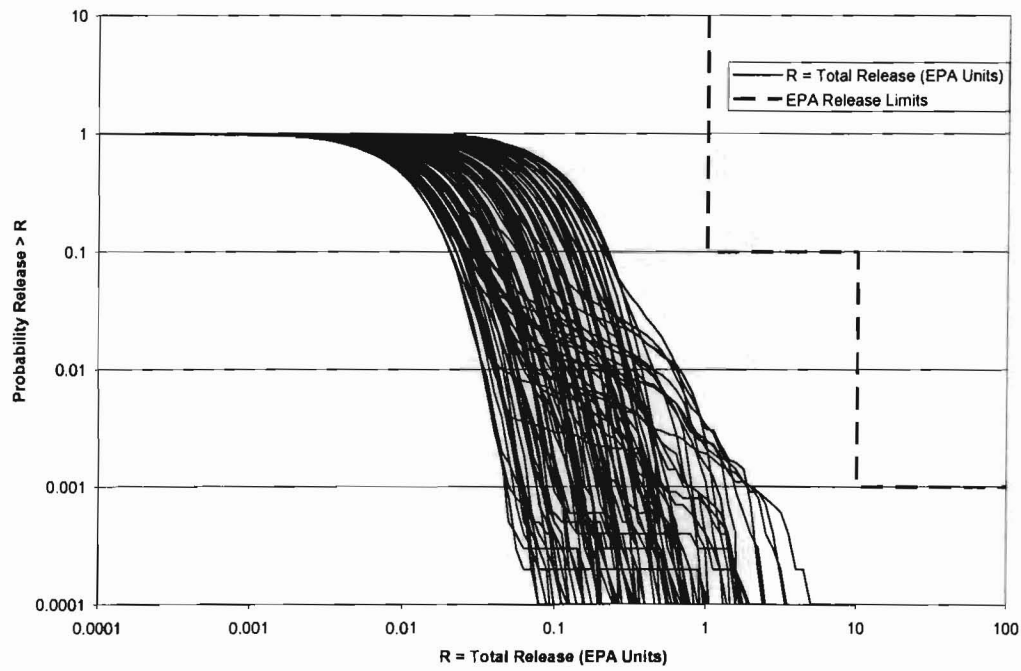

**Figure A. 1. Total Releases for SCPA Scenario 2, Replicate 1.**

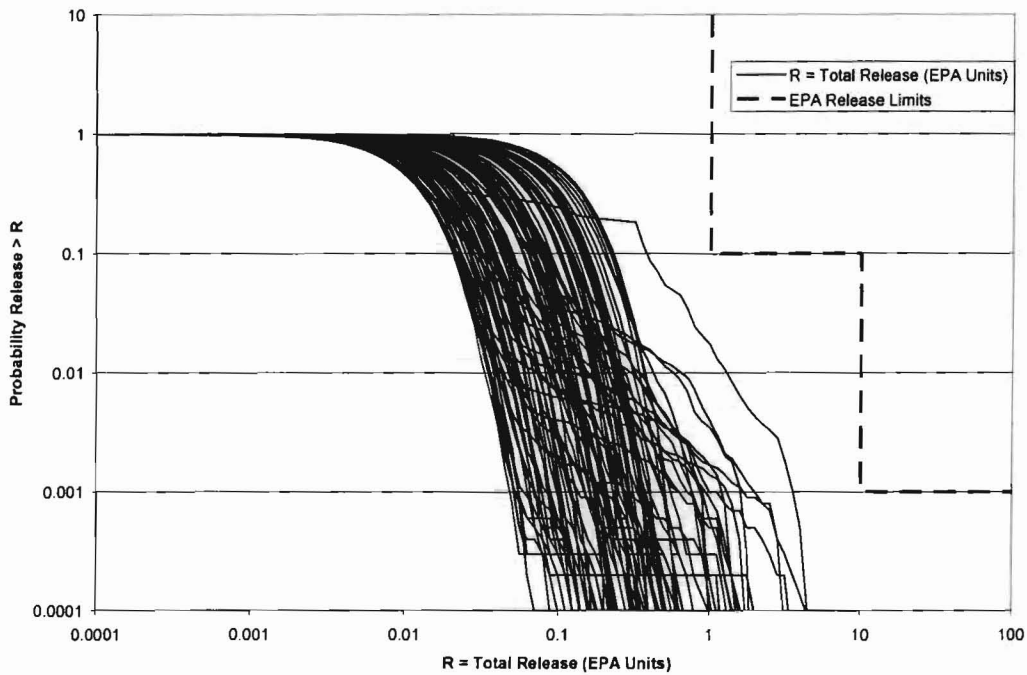

Figure A. 2. Total Releases for SCPA Scenario 2, Replicate 2.

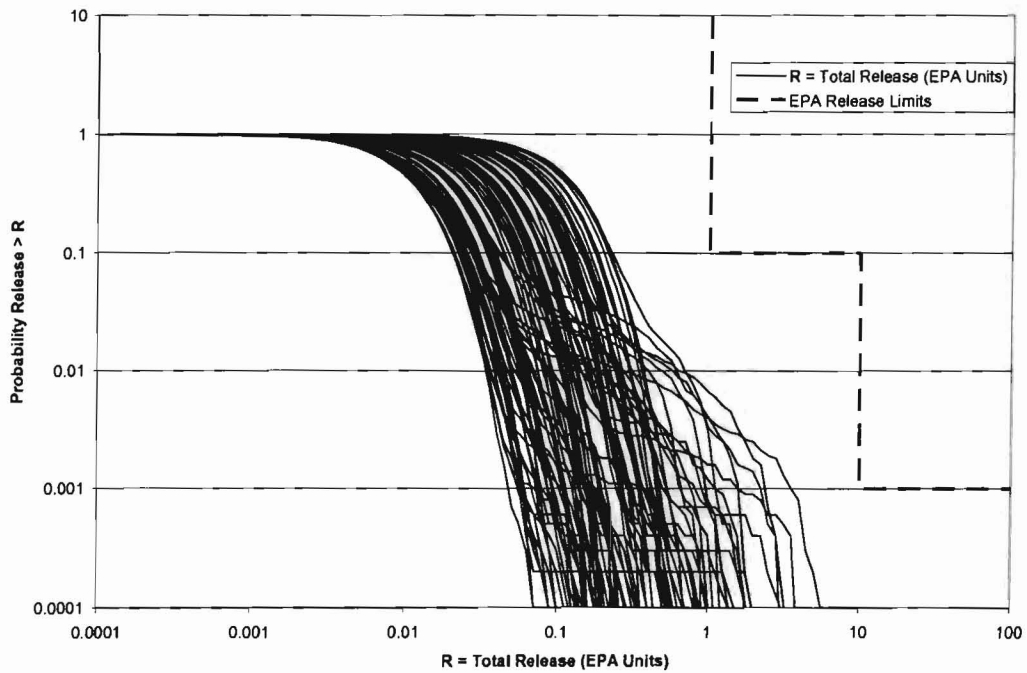

Figure A. 3. Total Releases for SCPA Scenario 2, Replicate 3.

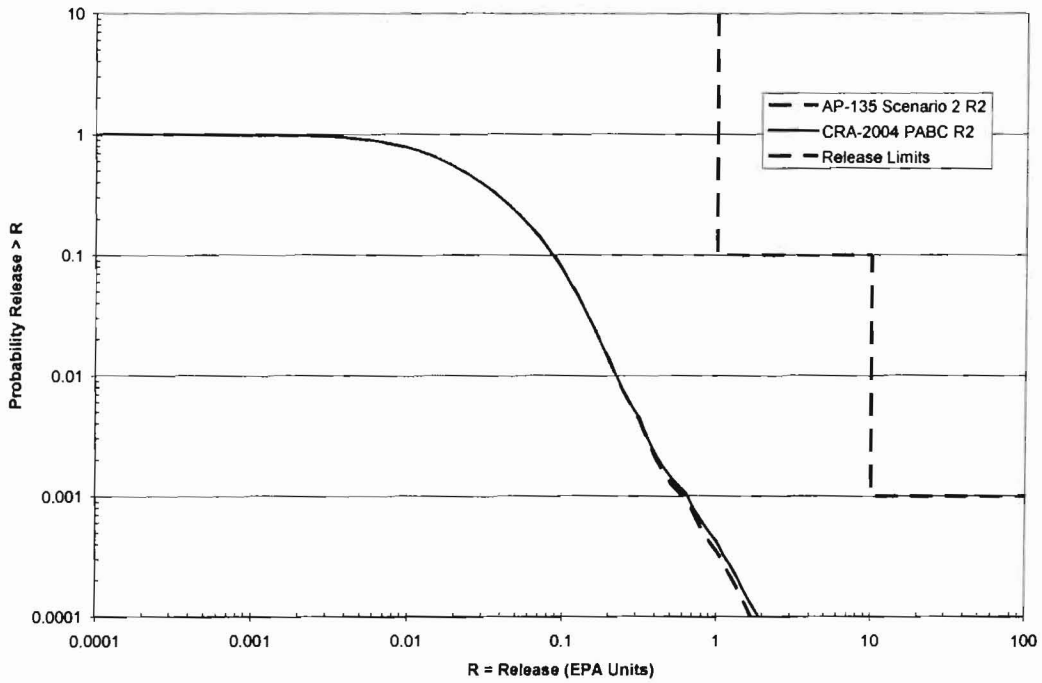

Figure A. 4. Mean Total Releases from SCPA Scenario 2 and CRA-2004 PABC, Replicate 2.

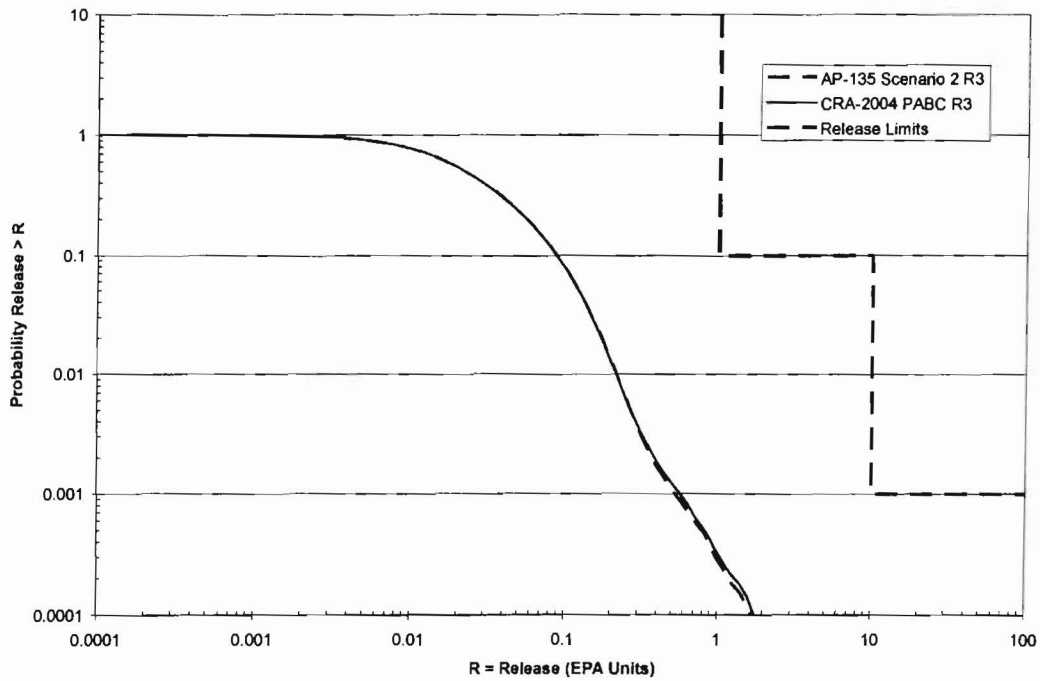

Figure A. 5. Mean Total Releases from SCPA Scenario 2 and CRA-2004 PABC, Replicate 3.

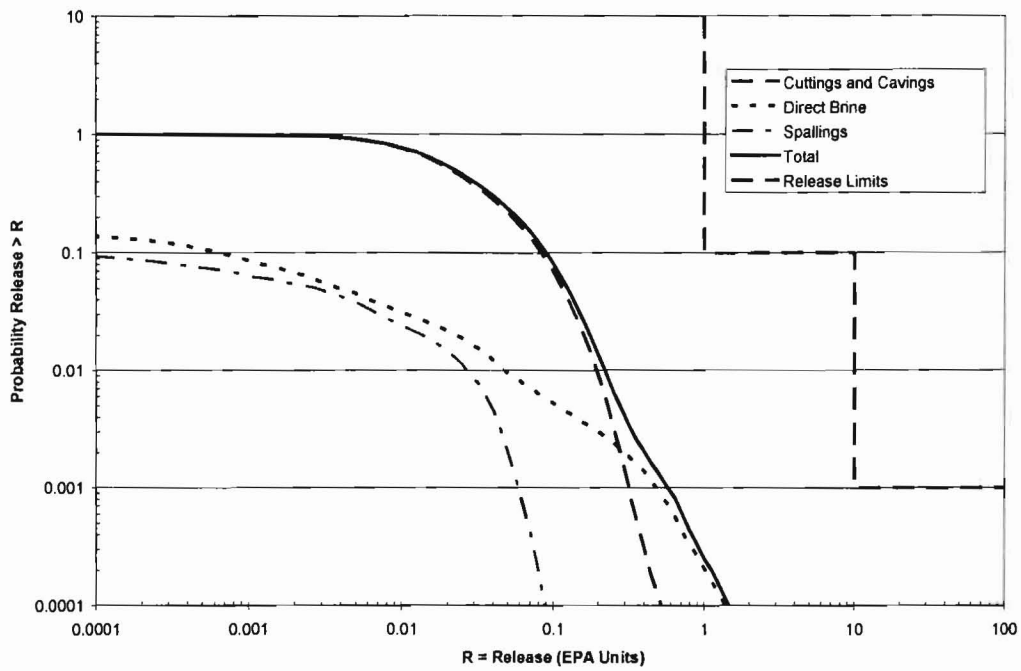

Figure A. 6. Mean Releases Mechanisms for SCPA Scenario 2, Replicate 1.

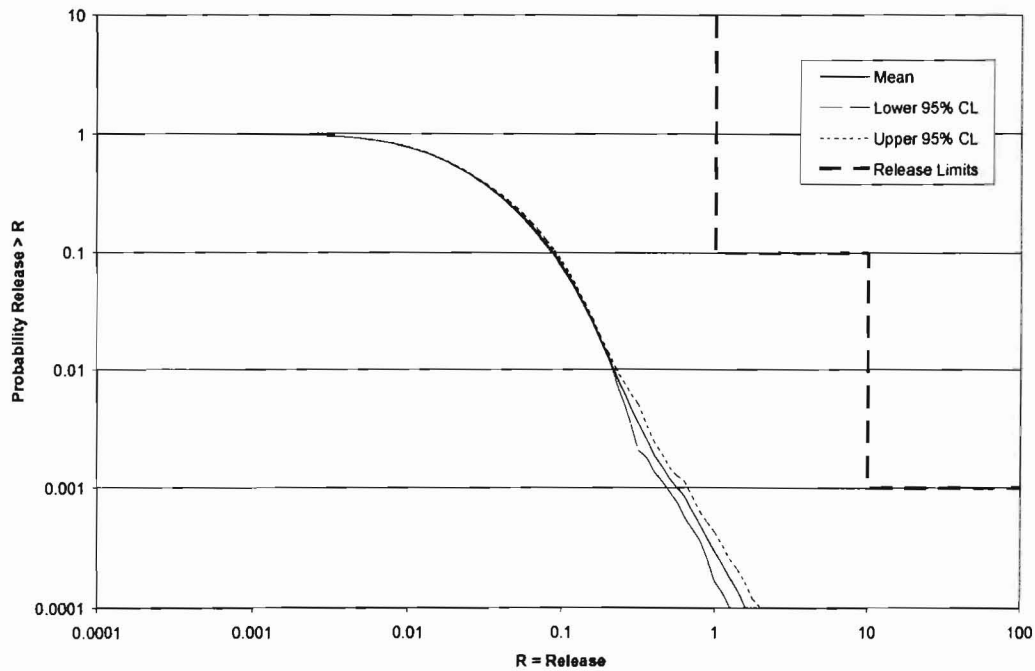

Figure A. 7. Total Release Confidence Intervals for SCPA Scenario 2.



**APPENDIX B: RUN CONTROL**

The SCPA used the WIPP PA codes listed in Table B. 1. These codes were executed on the WIPP PA Alpha Cluster, which is described in Table B. 2. The remaining tables contain the run control information for the execution of the SCPA calculations.

**Table B. 1. Codes Used for SCPA**

Code	Version	Build Date	Executable
CCDFGF	5.02	13-DEC-2004	CCDFGF_QB0502.EXE
EPAUNI	1.15A	03-JUL-2003	EPAUNI_QA0115A.EXE
PRECCDFGF	1.01	07-JUL-2005	PRECCDFGF_QA0101.EXE
POSTLHS	4.07A	25-APR-2005	POSTLHS_QA0407A.EXE
MATSET	9.10	29-NOV-2001	MATSET_QA0910.EXE
GENMESH	6.08	31-JAN-1996	GM_PA96.EXE

**Table B. 2. WIPP PA Alpha Cluster**

Node	Hardware Type	CPU	Operating System
CCR	HP AlphaServer ES45 Model 2	Alpha EV68	Open VMS 8.2
TDN	HP AlphaServer ES45 Model 2B	Alpha EV68	Open VMS 8.2
BTO	HP AlphaServer ES40	Alpha EV68	Open VMS 8.2
CSN	HP AlphaServer ES40	Alpha EV68	Open VMS 8.2
GNR	HP AlphaServer ES47	Alpha EV7	Open VMS 8.2
MC5	HP AlphaServer ES47	Alpha EV7	Open VMS 8.2
TRS	HP AlphaServer ES47	Alpha EV7	Open VMS 8.2
TBB	HP AlphaServer ES47	Alpha EV7	Open VMS 8.2

**Table B. 3. Inventory Decay Run Control Script**

Code	Script Name	CMS Library	CMS Class
EPAUNI	EVAL_EPU.COM	LIBAPI35_EVAL	API35-0

**Table B. 4 Inventory Decay Input and Output Files**

	File Names <sup>1</sup>	CMS Library	CMS Class
<b>SCRIPT</b>			
Input	EVAL_EPU_API35_x.INP	LIBAPI35_EVAL	API35-0
Log	EVAL_EPU_API35_x.LOG	LIBAPI35_EPU	API35-0
<b>EPAUNI</b>			
Input	EPU_API35_RH_x.INP	LIBAPI35_EPU	API35-0
Input	EPU_API35_RHS_MISC.INP	LIBAPI35_EPU	API35-0
Output	EPU_API35_RH_x.DAT	LIBAPI35_EPU	API35-0
Output	EPU_API35_RH_x.OUT	LIBAPI35_EPU	API35-0
Output	EPU_API35_RH_x.OUT2	LIBAPI35_EPU	API35-0
Output	EPU_API35_RH_x.DIA	LIBAPI35_EPU	API35-0

Output	EPU_AP135_RH_x_ACTIVITY.DIA	LIBAP135_EPU	AP135-0
--------	-----------------------------	--------------	---------

1.  $x \in \{HALF, INDIVIDUAL, TOTAL\}$

**Table B. 5. CCDF Construction Run Control Scripts**

Step	Codes in Step	Scripts	CMS Library	CMS Class
1	GENMESH MATSET	EVAL_GENERIC_STEP1.COM	LIBAP135_EVAL	AP135-0
2	POSTLHS	EVAL_CCGF_STEP2.COM	LIBAP135_EVAL	AP135-0
3	PRECCDFGF	EVAL_CCGF_STEP3.COM SUB_CCGF_STEP3.COM	LIBAP135_EVAL	AP135-0
4	CCDFGF	EVAL_CCGF_STEP4.COM SUB_CCGF_STEP4.COM	LIBAP135_EVAL	AP135-0

**Table B. 6. CCDF Construction Step 1 Input and Output Files**

	File Names <sup>1,2</sup>	CMS Library	CMS Class
<b>SCRIPT</b>			
Script Input	EVAL_CCGF_AP135_a_STEP1.INP	LIBAP135_EVAL	AP135-0
Script Log	EVAL_CCGF_AP135_a_STEP1.LOG	LIBAP135_CCGF	AP135-0
<b>GENMESH</b>			
Input	GM_CCGF_CRA1BC.INP	LIBCRA1BC_CCGF	AP135-0
Output	GM_CCGF_AP135_b.CDB	LIBAP135_CCGF	AP135-0
Output	GM_CCGF_AP135_b.DBG	NOT KEPT	NOT KEPT
<b>MATSET</b>			
Input	MS_CCGF_AP135_b.INP	LIBAP135_CCGF	AP135-0
Input	GM_CCGF_AP135_b.CDB	LIBAP135_CCGF	AP135-0
Output	MS_CCGF_AP135_b.CDB	LIBAP135_CCGF	AP135-0
Output	MS_CCGF_AP135_b.DBG	NOT KEPT	NOT KEPT

- $a \in \{IMPACT, S2, S3, S4\}$
- $b \in \{RH\_IMP, S2, S3, S4\}$

**Table B. 7. CCDF Construction Step 2 Input and Output Files**

	File Names <sup>1,2,3</sup>	CMS Library	CMS Class
<b>STEP 2</b>			
Script Input	EVAL_CCGF_AP135_STEP2_Rr_b.INP	LIBAP135_EVAL	AP135-0
Script Log	EVAL_CCGF_AP135_STEP2_Rr_b.LOG	LIBAP135_CCGF	AP135-0
<b>POSTLHS</b>			
Input	LHS3_DUMMY.INP	LIBCRA1BC_LHS	AP135-0
Input	LHS2_CRA1BC_Rr.TRN	LIBCRA1BC_LHS	AP135-0
Input	MS_CCGF_AP135_b.CDB	LIBAP135_CCGF	AP135-0
Output	LHS3_CCGF_AP135_Rr_b_Vvvv.CDB	LIBAP135_CCGF	AP135-0
Output	LHS3_CCGF_AP135_Rr_b.DBG	LIBAP135_CCGF	AP135-0

- $r \in \begin{cases} \{1,2,3\} & \text{for each S2 or no S} \\ \{1\} & \text{for each S3, S4, RH\_IMP} \end{cases}$
- $b \in \{RH\_IMP, S2, S3, S4\}$

3.  $vvv \in \{001, 002, \dots, 100\}$  for each  $r$

**Table B. 8. Construction Step 3 Input and Output Files**

	File Names <sup>1-8</sup>	CMS Library	CMS Class
<b>SCRIPT</b>			
Script Input	EVAL CCGF STEP3 AP135 R <sub>r</sub> b.INP	LIBAP135 EVAL	AP135-0
Script Log	EVAL CCGF STEP3 AP135 R <sub>r</sub> b.LOG	LIBAP135 CCGF	AP135-0
<b>PRECCDFGF</b>			
Input	INTRUSIONTIMES.IN	LIBCRA1BC CCGF	AP135-0
Input	MS CCGF AP135 b.CDB	LIBAP135 CCGF	AP135-0
Input	LHS3 CCGF AP135 R <sub>r</sub> b V <sub>vvv</sub> .CDB	LIBAP135 CCGF	AP135-0
Input	SUM_DBR CRA1BC R <sub>r</sub> S <sub>s</sub> T <sub>tttt</sub> c.TBL	LIBCRAB1C SUM	CRA1BC-1
Input	CUSP CRA1BC R <sub>r</sub> .TBL	LIBCRA1BC CUSP	CRA1BC-0
Input	SUM_NUT CRA1BC R <sub>r</sub> S1.TBL	LIBCRA1BC SUM	CRA1BC-1
Input	SUM_NUT CRA1BC R <sub>r</sub> S <sub>s</sub> T <sub>tttt</sub> .TBL	LIBCRA1BC SUM	CRA1BC-1
Input	SUM_PANEL_INT CRA1BC R <sub>r</sub> S <sub>6</sub> T <sub>tttt</sub> .TBL	LIBCRA1BC SUM	CRA1BC-0
Input	SUM_ST2D CRA1BC R <sub>r</sub> M <sub>m</sub> .TBL	LIBCRA1BC SUM	CRA1BC-0
Input	EPU AP135 RH x.DAT	LIBAP135 EPU	AP135-0
Input	EPU AP135 RH.DAT	LIBAP135 EPU	AP135-0
Input	SUM_PANEL_CON CRA1BC R <sub>r</sub> S <sub>s</sub> .TBL	LIBCRA1BC SUM	CRA1BC-0
Input	SUM_PANEL_ST CRA1BC R <sub>r</sub> S <sub>s</sub> .TBL	LIBCRA1BC SUM	CRA1BC-0
Output	CCGF AP135 RELTAB R <sub>r</sub> S <sub>s</sub> .DAT	LIBAP135 CCGF	AP135-0

1.  $r \in \begin{cases} \{1,2,3\} & \text{for each S2 or no S} \\ \{1\} & \text{for each S3, S4, RH IMP} \end{cases}$

2.  $vvv \in \{001, 002, \dots, 100\}$  for each  $r$

3.  $s \in \begin{cases} \{1, 2, 3, 4, 5\} & \text{for SUM\_DBR} \\ \{2, 3, 4, 5\} & \text{for SUM\_NUT} \\ \{1, 2\} & \text{for SUM\_PANEL\_CON and SUM\_PANEL\_ST} \end{cases}$

4.  $tttt \in \begin{cases} \{00100, 00350, 01000, 03000, 05000, 10000\} & \text{for S1 for each } r \text{ for SUM\_DBR} \\ \{00550, 00750, 02000, 04000, 10000\} & \text{for S2, S4 for each } r \text{ for SUM\_DBR} \\ \{01200, 01400, 03000, 05000, 10000\} & \text{for S3, S5 for each } r \text{ for SUM\_DBR} \\ \{00100, 00350\} & \text{for S2, S4 for each } r \text{ for SUM\_NUT} \\ \{01000, 03000, 05000, 07000, 09000\} & \text{for S3, S5 each } r \text{ for SUM\_NUT} \\ \{00100, 00350, 01000, 02000, 04000, 06000, 09000\} & \text{for each } r \text{ for SUM\_PANEL\_INT} \end{cases}$

5.  $c \in \{L, M, U\}$  for each intrusion for SUM\_DBR

6.  $m \in \{F, P\}$

7.  $b \in \{RH\_IMP, S2, S3, S4\}$

8.  $x \in \{HALF, INDIVIDUAL, TOTAL\}$

**Table B. 9. Construction Step 4 Input and Output Files**

	File Names <sup>1,2</sup>	CMS Library	CMS Class
<b>SCRIPT</b>			

Script Input	EVAL_CCGF_STEP4_API135_Rr_b.INP	LIBAPI135_EVAL	AP135-0
Script Log	EVAL_CCGF_STEP4_API135_Rr_b.LOG	LIBAPI135_CCGF	AP135-0
<b>CCDFGF</b>			
Input	CCGF_CRA1BC_CONTROL_Rr.INP	LIBCRA1BC_CCGF	AP135-0
Input	CCGF_API135_RELTAB_Rr_b.MOD.DAT*	LIBAPI135_CCGF	AP135-0
Input	CCGF_API135_RELTAB_Rr_b.DAT**	LIBAPI135_CCGF	AP135-0
Output	CCGF_API135_Rr_b.OUT	LIBAPI135_CCGF	AP135-0
Output	CCGF_API135_Rr_b.DBG	NOT KEPT	NOT KEPT

1.  $r \in \begin{cases} \{1,2,3\} & \text{for each S2} \\ \{1\} & \text{for each S3, S4, RH\_IMP} \end{cases}$

2.  $b \in \{RH\_IMP, S2, S3, S4\}$

\*File used for S2 and S4

\*\*File used for S3 and RH IMP

 11/8/07  
**Vugrin, Eric D**

INFORMATION ONLY

---

**From:** Long, Jennifer J  
**Sent:** Thursday, November 08, 2007 7:08 AM  
**To:** Vugrin, Eric D  
**Subject:** Signature Authority

Eric,

Please sign for me for the "Analysis Report for the Shielded Container Performance Assessment, Revision 1.0".

Thanks!

Jennifer

11/8/2007